

WaveDriver 200 Bipotentiostat/Galvanostat with EIS User Guide



Pine Research Instrumentation, Inc.
2741 Campus Walk Avenue
Building 100
Durham, NC 27705
USA

<https://www.pineresearch.com>
Phone: +1 919.782.8320 Fax: +1 919.782.8323
Copyright © 2021 Pine Research Instrumentation, Inc.



Table of Contents

1. Preface	1
1.1 Scope.....	1
1.2 Copyright.....	1
1.3 Trademarks	1
1.4 Use Limitation.....	1
1.5 Harmful or Corrosive Substances	2
1.6 Service and Warranty Information.....	3
1.7 Instrument Markings	4
1.7.1 Serial Number.....	4
1.7.2 Model Numbers	5
1.8 Icons (Icônes)	6
1.9 Safety Labels (<i>Étiquettes de sécurité</i>)	7
1.10 General Safety Warnings (<i>Avertissements de sécurité généraux</i>).....	8
1.11 Electrostatic Discharge Information	11
1.12 Hazardous Material Information	11
1.13 Software License	13
2. Product Specifications	15
2.1 Instrument Description	15
2.2 Software Description.....	15
2.3 Instrument Specifications.....	16
2.3.1 WaveDriver 200 Bipotentiostat/Galvanostat with EIS Specifications	16
2.3.2 EIS Accuracy Contour Plot	21
2.4 Standard Electrochemical Methods	23
2.5 System Components.....	24
2.6 Front Panel.....	25
2.7 Back Panel.....	27
2.8 Dummy Cell Description	30
3. System Installation	32
3.1 Physical Installation	32
3.1.1 Location.....	32
3.1.2 Glovebox Installation	32
3.1.3 Connecting the Power Supply to the Instrument	34
3.1.4 Connecting the Power Supply to the AC Mains.....	35
3.2 AfterMath Software Installation.....	36
3.2.1 Step-by-Step Software Installation Instructions	36
3.2.2 Permissions File Verification	42
3.3 USB Cable Connection.....	45

3.4	Installation Checklist	45
4.	System Testing	46
4.1	Test Setup.....	46
4.1.1	Launch the AfterMath Software	46
4.1.2	Verify Instrument Status	46
4.1.3	Confirm Connections	47
4.1.4	Review Instrument Status	48
4.2	Single Channel (K1) DC Test.....	49
4.2.1	Connect to the Pine Research Universal Dummy Cell.....	49
4.2.2	Create a Cyclic Voltammetry (CV) Experiment	50
4.2.3	Audit Experimental Parameters	50
4.2.4	Initiate the Experiment	50
4.2.5	Monitor Experimental Progress	51
4.2.6	Review the Results	52
4.2.7	Understanding the Results	52
4.3	Dual Channel (K1 and K2) DC Test	55
4.3.1	Connect to the Pine Research Universal Dummy Cell.....	55
4.3.2	Create a Dual Electrode Cyclic Voltammetry (DECV) Experiment	55
4.3.3	Modify the Potential Range Setting	56
4.3.4	Audit Experimental Parameters	56
4.3.5	Initiate the Experiment	56
4.3.6	Monitor Experimental Progress	56
4.3.7	Review the Results	58
4.3.8	Understanding the Results	58
4.4	Cell Cable Calibration.....	59
4.4.1	Connect to the Pine Research Universal Dummy Cell.....	60
4.4.2	Create a Cable Calibration (EIS-CCAL) Experiment.....	60
4.4.3	Initiate the Experiment	60
4.4.4	Monitor Experimental Progress	60
4.4.5	Review the Results	62
4.5	Open Lead Test	64
4.5.1	Arrange the Cell Cable	64
4.5.2	Create a Potentiostatic EIS Experiment (EIS-POT)	66
4.5.3	Audit Experimental Parameters	66
4.5.4	Initiate the Experiment	66
4.5.5	Monitor Experimental Progress	66
4.5.6	Review the Results	67
4.6	Shorted Lead Test.....	68
4.6.1	Low Inductance Cell Cable Configuration.....	68
4.6.2	Create a Galvanostatic EIS Experiment (EIS-GAL)	69
4.6.3	Audit Experimental Parameters	69

4.6.4	Initiate the Experiment	70
4.6.5	Monitor Experimental Progress	70
4.6.6	Review the Results	73
4.7	Simple EIS Test	74
4.7.1	Connect to the Pine Research Universal Dummy Cell.....	74
4.7.2	Create a Potentiostatic EIS Experiment (EIS-POT)	74
4.7.3	Audit Experimental Parameters	74
4.7.4	Initiate the Experiment	75
4.7.5	Monitor Experimental Progress	76
4.7.6	Review the Results	77
4.7.7	Understanding the Results	79
4.7.8	Performing a Circuit Fit Analysis	80
4.7.9	Saving the Fitting Results	81
5.	Cell Cable Connections	83
5.1	Cell Cable Color Code.....	83
5.2	Experimental Configurations	85
5.2.1	Two-Electrode Setups.....	86
5.2.2	Three-Electrode Cells	87
5.2.3	Rotating Disk and Rotating Cylinder Electrodes (RDE and RCE)	89
5.2.4	Rotating Ring-Disk Electrodes (RRDE)	89
5.2.5	Rotation Rate Control	91
5.2.6	Compact Voltammetry Cell Cable Connections	93
6.	Grounding Information	95
6.1	Common Noise Sources	95
6.2	Grounding Terminology	95
6.2.1	Earth Ground.....	95
6.2.2	Chassis Terminal	97
6.2.3	DC Common	97
6.3	Faraday Cages	98
6.4	Metal Apparatus	99
6.5	USB Isolation	99
6.6	Grounding Strategies	100
6.7	Grounding Third-Party Instrumentation.....	100
7.	Power Cords	104
8.	Theory	107
8.1	Electrochemical Impedance Spectroscopy	107
8.1.1	Basic Background Theory	107
8.1.2	Mathematical Theory	109
8.1.3	EIS Data Plotting.....	111

8.1.4	Data Accuracy and Validity	113
8.1.5	Kramers-Kronig	116
8.2	References.....	118
9.	Glossary	120
10.	Appendix I: Legacy Dummy Cell Information (before NOV 2020)	123
10.1	Legacy Dummy Cell Description	123
10.2	Connecting to Row "C" on the EIS Calibration & Dummy Cell	124
10.3	Connecting to Row "CAL" on the EIS Calibration & Dummy Cell	125
10.4	Connecting to Row "EIS" on the EIS Calibration & Dummy Cell.....	125
11.	Appendix II. Legacy Grounding Information (before APR 2021)	127
12.	Customer Support	129
12.1	Online.....	129
12.2	By E-mail.....	129
12.3	By Phone.....	129

Table of Tables

Table 1-1. WaveDriver Instrument Model Numbers and Model Names	5
Table 1-2. Special Icons used in this Document.	5
Table 1-3. Safety Warning Icons used in this Document.	6
Table 1-4. Other Safety Warning Icons used in this Document	7
Table 1-5. Hazardous Materials Disclosure (English)	12
Table 1-6. Hazardous Materials Disclosure (Mandarin).....	12
Table 2-1. Electrochemical Techniques in AfterMath.....	23
Table 2-2. Main Components Included with WaveDriver 200 Bipotentiostat	24
Table 2-3. Front Panel of the WaveDriver 200 Bipotentiostat.....	25
Table 2-4. Overview of WaveDriver 200 Bipotentiostat LED Indicator Lights	26
Table 2-5. WaveDriver 200 Back Panel Connector Descriptions.....	28
Table 3-1. Computer System Requirements for AfterMath Software	36
Table 5-1. WaveDriver 200 Cell Cable Color Description.....	83
Table 7-1. Select Power Cords Available from Pine Research	106

Table of Figures

Figure 1-1. WaveDriver 200 Instrument Markings	4
Figure 1-2. Safety Warning Labels on Back Panel of Instrument	7
Figure 2-1. WaveDriver 200 Bipotentiostat/Galvanostat EIS Accuracy Contour Plot	21
Figure 2-2. WaveDriver 200 Back Panel Connections.....	27
Figure 2-3. WaveDriver 200 Control Ports A, B, and C Pinouts	29
Figure 2-4. WaveDriver 200 Pine Research Universal Dummy Cell (with Schematic Diagrams)	30
Figure 3-1. USB Cable Glovebox Feedthrough.....	33
Figure 3-2. Cell Cable Glovebox Feedthrough	33
Figure 3-3. Power Supply with Low Voltage (24 VDC) Cable Connection to Back Panel.....	34
Figure 3-4. Welcome to AfterMath Setup Wizard Dialog Box	37
Figure 3-5. AfterMath Installation License Agreement	37
Figure 3-6. AfterMath Installation Options	38
Figure 3-7. Selecting AfterMath Installation Folder and User Access.....	38
Figure 3-8. Confirm Installation of AfterMath	39
Figure 3-9. Installation Progress of AfterMath.....	39
Figure 3-10. Device Driver Installation Wizard	40
Figure 3-11. USB/Device Driver Installation Progress.....	40
Figure 3-12. USB/Device Driver Installation Completion	41
Figure 3-13. Windows Security Prompt to Install Device Software.....	41
Figure 3-14. Confirmation of Successful AfterMath Installation	42
Figure 3-15. Permissions Files on Installation Media	43
Figure 3-16. Indications that the AfterMath License is not Active	43
Figure 3-17. Copying Permissions Files to AfterMath	44
Figure 3-18. USB Cable Connection Between Potentiostat and Computer	45
Figure 4-1. Initial Login Screen when Starting AfterMath.....	46
Figure 4-2. AfterMath Screenshot with Connected Instrument Circled	47
Figure 4-3. Indicator Lights on the Front Panel of the WaveDriver 200	47
Figure 4-4. AfterMath Instrument Status Window showing External Cell Idle Conditions	48
Figure 4-5. WaveDriver 200 Cell Cable Connected to "Cell C" of Dummy Cell.....	49
Figure 4-6. Cyclic Voltammetry (CV) Parameters Dialog Window	50
Figure 4-7. Location of Instrument Selection Menu and Perform Button	51
Figure 4-8. Monitoring the Progress of the CV Experiment.....	52
Figure 4-9. Anticipated CV Results (using "Cell C" of Dummy Cell)	53
Figure 4-10. Analyzed CV Results (using "Cell C" of Dummy Cell).....	54
Figure 4-11. Dual Electrode Cyclic Voltammetry (DECV) Parameters Dialog Window.....	55
Figure 4-12. Adjusting the Potential Ranges on the "Ranges" Tab (DECV)	56
Figure 4-13. Location of Instrument Selection Menu and Perform Button (DECV).....	57
Figure 4-14. Monitoring the Progress of the DECV Experiment (K1 and K2)	57
Figure 4-15. Anticipated DECV Results (using "Cell C" of Dummy Cell)	58
Figure 4-16. Analyzed DECV Results (using "Cell C" of Dummy Cell)	59

Figure 4-17. WaveDriver 200 Cell Cable Connected to "Cable Calibration" on Dummy Cell.....	60
Figure 4-18. Cable Calibration (EIS-CCAL) Experiment Dialog Window	61
Figure 4-19. Monitoring the Progress of the EIS-CCAL Experiment	62
Figure 4-20. Anticipated EIS-CCAL Results (using "Cable Calibration" on Dummy Cell)	63
Figure 4-21. Proper Cable Arrangement for an Open Lead EIS Measurement	64
Figure 4-22. Parameters used for an Open Lead EIS Test.....	65
Figure 4-23. Location of Instrument Selection Menu and Perform Button (EIS-POT)	66
Figure 4-24. Monitoring the Progress of the EIS-POT Open Lead Experiment	67
Figure 4-25. Bode Plot for a Typical Open Lead EIS Test	68
Figure 4-26. Braided Cell Cable Configuration for Low Inductance Load Measurement.....	69
Figure 4-27. Proper Cable Arrangement for a Shorted Lead EIS Measurement	70
Figure 4-28. Parameters used for a Shorted Lead EIS Test.....	71
Figure 4-29. Location of Instrument Selection Menu and Perform Button (EIS-GAL).....	72
Figure 4-30. Monitoring the Progress of the EIS-GAL Shorted Lead Experiment	72
Figure 4-31. Bode Plot for a Typical Shorted Lead EIS Test	73
Figure 4-32. WaveDriver 200 Cell Cable Connected to "EIS" on Dummy Cell.....	74
Figure 4-33. Experimental Parameters for a Simple EIS Test	75
Figure 4-34. Location of Instrument Selection Menu and Perform Button (EIS-POT)	76
Figure 4-35. Monitoring the Progress of the EIS-POT Simple AC Test Experiment	77
Figure 4-36. Anticipated EIS-POT Results – Bode Plot (using "EIS" on Dummy Cell)	78
Figure 4-37. Anticipated EIS-POT Results – Nyquist Plot (using "EIS" on Dummy Cell)	78
Figure 4-38. Additional Results Node from EIS-POT Simple AC Test Experiment.....	79
Figure 4-39. Location of Circuit Fit Analysis in AfterMath.....	80
Figure 4-40. Circuit Library Selection for Circuit Fit Analysis.....	80
Figure 4-41. Circuit Fit Analysis Results for EIS Dummy Cell	82
Figure 4-42. Circuit Fit Calculated Values Tab with Parameter Values and Uncertainties	82
Figure 5-1. WaveDriver 200 Cell Port and Cell Cable Pinout	84
Figure 5-2. Secure Connection of the WaveDriver 200 Cell Cable to the Cell Port	85
Figure 5-3. Unused K2 Electrode Lines	85
Figure 5-4. Examples of Two-Electrode Setups	86
Figure 5-5. Typical Three-Electrode Cell Configuration	88
Figure 5-6. Working Electrode Sense and Drive Leads (K1) Shorted Together near the Electrode	89
Figure 5-7. Working Electrode Connection for a Rotating Disk or Rotating Cylinder Electrode.....	90
Figure 5-8. Electrode Connections for a Rotating Ring-Disk Electrode	91
Figure 5-9. Rotation Rate Control Connections for a Pine Research MSR Rotator	92
Figure 5-10. Rotation Rate Control Connections for a Pine Research WaveVortex 10 Rotator.....	93
Figure 5-11. Cable Connections for the Compact Voltammetry Cell Kit	94
Figure 6-1. Location of Earth Ground on Common Electrical Receptacles	96
Figure 6-2. A Typical Earth Ground Connection Adapter with Banana Cable.....	96
Figure 6-3. Common Examples of Faraday Cages.....	99
Figure 6-4. Metal Objects Near the Electrochemical Cell Should Be Grounded.....	99
Figure 6-5. Four Common Instrument Grounding Configurations	101

Figure 6-6. Connect All Instrument Chassis Terminals to a Common Point	102
Figure 8-1. AC Electrochemistry Sine Wave Input and Output Terminology	108
Figure 8-2. Examples of Typical Lissajous Plots for Stable and Linear Systems	108
Figure 8-3. Example Nyquist Plots for Different Circuit Networks	111
Figure 8-4. Example Bode Plots for Different Circuit Networks.....	112
Figure 8-5. Drifting Baseline Effect on Sinusoidal Signal and Lissajous Plot	114
Figure 8-6. Illustration of EIS Causality Condition	115
Figure 8-7. Examples of Possible Lissajous Plots for Nonlinear Systems	116
Figure 8-8. Representative Circuit Used in Kramers-Kronig Fitting	116
Figure 8-9. Effect of Drift on EIS Data and Kramers-Kronig Analysis	117
Figure 10-1. WaveDriver 200 Legacy EIS Calibration & Dummy Cell (with Schematic Diagrams)	123
Figure 10-2. WaveDriver 200 Cell Cable Connected to Dummy Cell Row "C"	124
Figure 10-3. WaveDriver 200 Connections for Cell Cable Calibration	125
Figure 10-4. WaveDriver 200 Connections for a Simple EIS Test.....	126
Figure 11-1. Four Common Instrument Grounding Configurations	128

1. Preface

1.1 Scope

This user guide describes the WaveDriver 200 Bipotentiostat/Galvanostat with EIS system. The target audience for this user guide is a professional scientist or engineer (or student of science and engineering) with a basic knowledge of scientific measurement, data presentation, and electrochemistry. Practical aspects of making electrochemical measurements using the WaveDriver 200 instrument are discussed, and a terse introduction to Electrochemical Impedance Spectroscopy (EIS) theory is also included.

A small portion of this guide is dedicated to the subject of using the AfterMath software package to control the WaveDriver 200 instrument. This information about AfterMath is limited primarily to the subject of installing the software, connecting to the instrument, and verifying that the system works correctly. More extensive descriptions of how to use the AfterMath software may be found in the documents listed below:

- *AfterMath User Guide* (describes plotting and analysis functions)
- *AfterMath Electrochemistry Guide* (describes electrochemical techniques)

Both of the additional documents listed above are available online at the following URL:

<https://www.pineresearch.com/shop/knowledgebase/>

1.2 Copyright

This publication may not be reproduced or transmitted in any form, electronic or mechanical, including photocopying, recording, storing in an information retrieval system, or translating, in whole or in part, without the prior written consent of Pine Research Instrumentation, Inc.

1.3 Trademarks

All trademarks are the property of their respective owners. *Windows* is a registered trademark of Microsoft Corporation (Redmond, WA). *WaveDriver*[®], *WaveVortex*[®] and *AfterMath*[®] are registered trademarks of Pine Research Instrumentation, Inc. (Durham, NC).

1.4 Use Limitation

The WaveDriver 200 instrument is not designed for use in experiments involving human subjects and/or the use of electrodes inside or on the surface of the human body.

Any use of this instrument other than its intended purpose is prohibited.

1.5 Harmful or Corrosive Substances

The operator of the WaveDriver 200 should have prior experience working in a chemical laboratory and knowledge of the safety issues associated with working in chemical laboratory. Electrochemical experiments may involve the use of harmful or corrosive substances, and the operator should wear personal protective equipment while working with these substances. At a minimum, the operator should wear the following items to avoid contact with harmful or corrosive substances:

- Eye protection (safety goggles, face shield, etc.)
- Laboratory coat (flame- and solvent-resistant)
- Solvent-resistant gloves
- Closed-toe shoes

Additional personal protective clothing and equipment may be required depending upon the nature of the chemicals used in an experiment. A complete discussion of chemical laboratory safety practices is beyond the scope of this user guide, and the reader is directed to the CHEMICAL SAFETY BIBLIOGRAPHY below for additional information.

CHEMICAL SAFETY BIBLIOGRAPHY BIBLIOGRAPHIE DE SÉCURITÉ CHIMIQUE

1. American Chemical Society Committee on Chemical Safety Hazards Identification and Evaluation Task Force, *Identifying and Evaluating Hazards in Research Laboratories: Guidelines Developed by the Hazards Identification and Evaluation Task Force of the ACS Committee on Chemical Safety*; American Chemical Society, 2013.
2. National Research Council (US), Division of Earth and Life Studies, Board of Chemical Sciences and Technology, Committee on Prudent Practices in the Laboratory, *Prudent Practices in the Laboratory: Handling and Management of Chemical Hazards, Updated Version*; National Academies Press, 2011.
3. American Chemical Society Committee on Chemical Safety. *Safety in Academic Chemistry Laboratories*; 7th ed.; American Chemical Society: State College, PA, 2003; Vol. 2.

L'opérateur du WaveDriver 200 doit avoir une expérience préalable de travail dans un laboratoire de chimie et la connaissance des mesures de sécurité associées aux travaux dans un laboratoire de chimie. Les expériences en électrochimie peuvent impliquer l'utilisation de substances nocives ou corrosives, et l'opérateur doit porter des équipements de protection individuelle lorsqu'il travaille avec ces substances. Au minimum, l'opérateur doit porter les articles suivants pour éviter le contact avec les substances nocives ou corrosives :

- Protection des yeux (lunettes de sécurité, masque de protection facial, ect.)
- Blouse de laboratoire (résistante au feu et résistante aux solvants)
- Gants de protection résistants aux solvants
- Chaussures fermées

Des vêtements et équipements de protection individuelle supplémentaires peuvent être requis en fonction de la nature des produits chimiques utilisés dans une expérience. Une discussion complète des pratiques de sécurité de laboratoire chimique est au-delà de la portée de ce guide de l'utilisateur, et le lecteur est dirigé vers la « BIBLIOGRAPHIE DE SÉCURITÉ CHIMIQUE » ci-dessus pour des informations supplémentaires.

1.6 Service and Warranty Information

For questions about proper operation of the WaveDriver 200 system or other technical issues, please use the contact information below to contact Pine Research directly.

TECHNICAL SERVICE CONTACT

Pine Research Instrumentation, Inc.
<https://www.pineresearch.com>
 Phone: +1 (919) 782-8320
 Fax: +1 (919) 782-8323
 Email: pinewire@pineresearch.com

If the WaveDriver 200 system or one of its components or accessories must be returned to the factory for service, please contact Technical Service (see above) to obtain a Return Material Authorization (RMA) form. Include a copy of this RMA form in each shipping carton and ship the cartons to the Factory Return Service Address (below).

FACTORY RETURN SERVICE ADDRESS

Pine Instrument Company
 ATTN: RMA # <RMA number>
 104 Industrial Drive
 Grove City, PA 16127
 USA



RETURN MATERIAL AUTHORIZATION REQUIRED!

Do not ship equipment to the factory without first obtaining a Return Material Authorization (RMA) from Pine Research.

LIMITED WARRANTY

The WaveDriver 200 Bipotentiostat/Galvanostat with EIS instrument (hereafter referred to as the "INSTRUMENT") offered by Pine Research Instrumentation (hereafter referred to as "PINE") is warranted to be free from defects in material and workmanship for a one (1) year period from the date of shipment to the original purchaser (hereafter referred to as the "CUSTOMER") and used under normal conditions. The obligation under this warranty is limited to replacing or repairing parts which shall upon examination by PINE personnel disclose to PINE's satisfaction to have been defective. The customer may be obligated to assist PINE personnel in servicing the INSTRUMENT. PINE will provide telephone support to guide the CUSTOMER to diagnose and effect any needed repairs. In the event that telephone support is unsuccessful in resolving the defect, PINE may recommend that the INSTRUMENT be returned to PINE for repair. This warranty being expressly in lieu of all other warranties, expressed or implied and all other liabilities. All specifications are subject to change without notice.

The CUSTOMER is responsible for charges associated with non-warranted repairs. This obligation includes but is not limited to travel expenses, labor, parts and freight charges.



1.7 Instrument Markings

Labels located on the back panel of each individual WaveDriver 200 include information about the make, model, and serial number of the instrument. These labels also indicate any certifications or independent testing agency marks that pertain to the instrument (see Figure 1-1).

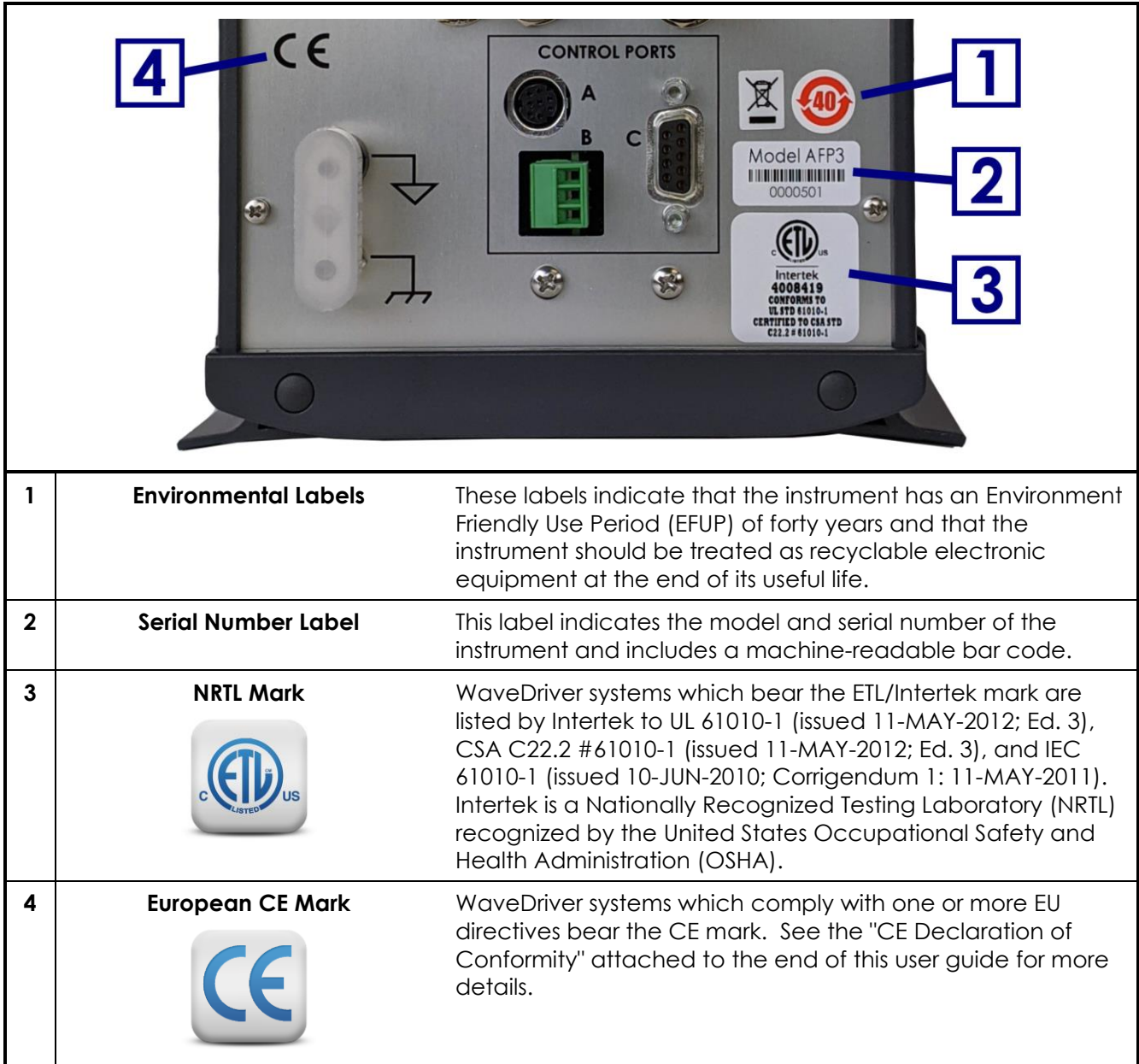

Figure 1-1. WaveDriver 200 Instrument Markings

1.7.1 Serial Number

For purposes of uniquely identifying a particular instrument, there is a label on the back panel of each WaveDriver 200 instrument that indicates the model number and the serial number. The serial number is also encoded with a machine-readable barcode on the same label (see Figure 1-1).

1.7.2 Model Numbers

The relationship between the model name and model number for the WaveDriver 200 system is described below (see Table 1-1). The model number has the format "AFP N X Y " where N is a single numeric digit (either 3 or 4), and X and Y are either blank or uppercase alphabetic characters. Pine Research part numbers for various components of the system (such as power cords, cell cables, and accessories) are described in more detail later (see Sections 5 and 7).

Model Number:	A	F	P	N	X	Y	Model Name
	A	F	P	3			WaveDriver 200
	A	F	P	4			WaveDriver 40
	A	F	P	5			WaveDriver 100

Table 1-1. WaveDriver Instrument Model Numbers and Model Names

The WaveDriver 40 is a bipotentiostat/galvanostat similar to the WaveDriver 200 that may be used to perform traditional electroanalytical experiments but does not perform Electrochemical Impedance Spectroscopy (EIS) methods. The WaveDriver 100 is a potentiostat/galvanostat (meaning it has only one working electrode channel, unlike the WaveDriver 200 that is a bipotentiostat and has two), and it may also be used to perform EIS methods.



	<p>STOP:</p> <p>For a procedure involving user action or activity, this icon indicates a point in the procedure where the user must stop the procedure.</p> <p>ARRÊT:</p> <p><i>Dans une opération impliquant l'action ou l'activité d'un utilisateur, cette icône indique l'étape où l'utilisateur doit arrêter l'opération.</i></p>
	<p>NOTE:</p> <p>Important or supplemental information.</p> <p>REMARQUE:</p> <p><i>Renseignements importants ou complémentaires.</i></p>
	<p>TIP:</p> <p>Useful hint or advice.</p> <p>CONSEIL:</p> <p><i>Astuce ou conseil utile.</i></p>

Table 1-2. Special Icons used in this Document.

(Tableau 1-2. Icônes spéciales utilisées dans ce document)

1.8 Icons (Icônes)

Special icons are used to call attention to safety warnings and other useful information found in this document (see Table 1-2, Table 1-3, and Table 1-4).

Des icônes spéciales (voir Tableau 1-2, Tableau 1-3, et Tableau 1-4) sont utilisées pour attirer l'attention sur des avertissements de sécurité et d'autres renseignements utiles disponibles dans ce document.



	<p>WARNING: Indicates information needed to prevent injury or death to a person or to prevent damage to equipment.</p> <p>AVERTISSEMENT: Indique les informations nécessaires pour prévenir les blessures ou le décès d'une personne ou pour éviter d'endommager l'équipement.</p>
	<p>ROTATING SHAFT HAZARD: Indicates information needed to prevent injury or death to a person due to a high-speed rotating shaft.</p> <p>DANGER LIÉ À LA ROTATION DE L'ARBRE: <i>Indique les informations nécessaires pour prévenir les blessures ou le décès d'une personne à cause de la vitesse élevée de rotation de l'arbre.</i></p>
	<p>RISK OF ELECTRICAL SHOCK: Indicates information needed to prevent injury or death to a person due to electrical shock.</p> <p>RISQUE DE DÉCHARGE ÉLECTRIQUE: <i>Indique les informations nécessaires pour prévenir les blessures ou le décès d'une personne à cause d'une décharge électrique.</i></p>

Table 1-3. Safety Warning Icons used in this Document.

(Tableau 1-3. Icônes d'avertissement de sécurité utilisées dans ce document)



	<p>CAUTION: Indicates information needed to prevent damage to equipment.</p> <p>ATTENTION: Indique les informations nécessaires pour éviter d'endommager l'équipement.</p>
	<p>RISK OF ELECTROSTATIC DAMAGE: Indicates information needed to prevent damage to equipment due to electrostatic discharge.</p> <p>RISQUE DE DOMMAGES ÉLECTROSTATIQUES: Indique les informations nécessaires pour éviter d'endommager l'équipement à cause d'une décharge électrostatique.</p>
	<p>TEMPERATURE CONSTRAINT: Indicates when an operation or use of equipment is limited to a specified temperature range.</p> <p>CONTRAINTES DE TEMPÉRATURE : Indique lorsqu'une opération ou un usage de matériel est limité à une plage de températures spécifique.</p>

Table 1-4. Other Safety Warning Icons used in this Document

(Tableau 1-4: Autres Icônes d'avertissement de sécurité utilisées dans ce document)

1.9 Safety Labels (Étiquettes de sécurité)

Specific safety warnings are found on labels attached to the instrument (see Figure 1-2).

Les avertissements de sécurité spécifiques suivants se trouvent sur les étiquettes apposées sur l'instrument (voir Figure 1-2).

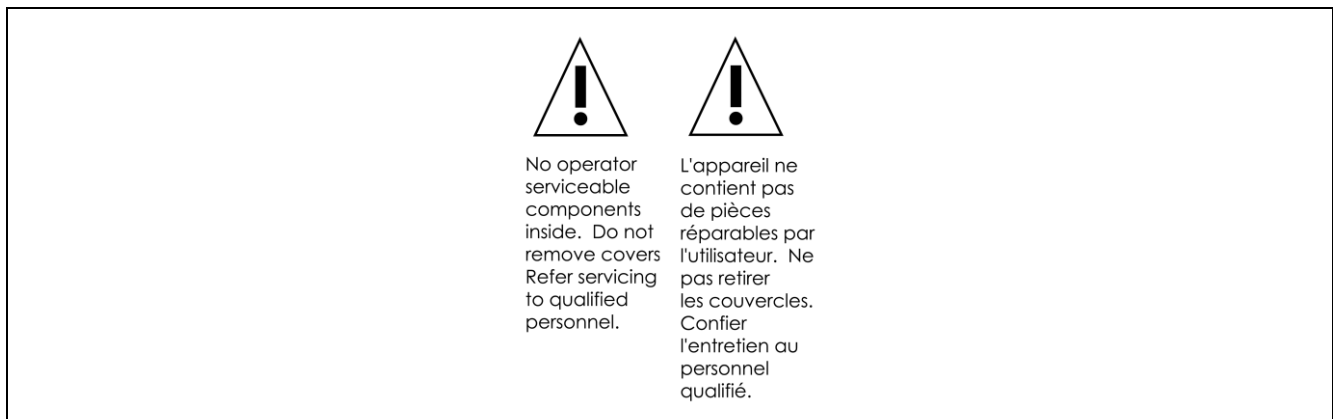

Figure 1-2. Safety Warning Labels on Back Panel of Instrument

1.10 General Safety Warnings (Avertissements de sécurité généraux)

The following safety warnings pertain to general use of the instrument. More specific safety warnings are found in later sections of this document that pertain to particular operations and procedures involving the instrument.

Des avertissements de sécurité plus spécifiques se trouvent dans les sections suivantes de ce document, concernant les opérations et les procédures particulières relatives à l'instrument.



WARNING:

There are no user serviceable components inside the WaveDriver 200 chassis. Do not remove the chassis covers. Refer any service issue to qualified personnel.

AVERTISSEMENT:

Le châssis de l'appareil WaveDriver 200 ne comporte aucune pièce pouvant être remplacée par l'utilisateur. Ne retirez pas les protections du châssis. Signalez tout problème d'entretien au personnel qualifié.



WARNING:

A factory-approved power supply is provided with the WaveDriver 200. Do not use a power supply that is not factory-approved.

AVERTISSEMENT:

Une alimentation électrique approuvée par le constructeur est fournie avec l'appareil WaveDriver 200. N'utilisez pas une alimentation électrique non approuvée par le constructeur.



WARNING:

Connect the power supply to the AC mains using the power cord supplied with the WaveDriver 200 and certified for the country of use (see Section 7 of this User Guide for more details). Do not replace this cord with an inadequately rated cord.

AVERTISSEMENT:

Connectez le bloc d'alimentation au secteur à l'aide du cordon d'alimentation fourni avec l'appareil WaveDriver 200 et conforme aux réglementations du pays d'utilisation (pour plus de détails, consultez la partie 7 du présent mode d'emploi). Ne remplacez pas ce cordon par un cordon de calibre inadéquat.

**WARNING:**

Do not block access to the power supply or the power cord. The user must have access to disconnect the power supply or the power cord from the AC mains at all times.

AVERTISSEMENT:

Ne bloquez pas l'accès au bloc d'alimentation ou au cordon d'alimentation. L'utilisateur doit être en mesure de déconnecter le bloc d'alimentation ou le cordon d'alimentation du secteur à tout moment.

**WARNING:**

The switch on the front of the WaveDriver 200 turns the power to the instrument on and off. Do not block access to the switch. The user must have access to the switch at all times.

AVERTISSEMENT:

L'interrupteur situé sur le devant de l'appareil WaveDriver 200 permet de couper l'alimentation. Ne bloquez pas l'accès à l'interrupteur. L'utilisateur doit avoir accès à l'interrupteur à tout moment.

**WARNING:**

Do not operate the WaveDriver 200 in an explosive atmosphere.

ATTENTION:

N'utilisez pas l'appareil WaveDriver 200 dans une atmosphère explosive.

**CAUTION**

Provide proper ventilation for the WaveDriver 200. Maintain at least two inches (50 mm) of clearance around the sides (left, right, and back) and above (top) the instrument.

ATTENTION:

Assurez-vous que l'appareil WaveDriver 200 soit correctement ventilé. Laissez au moins 50 mm (2 po) autour de l'appareil (à gauche, à droite et derrière), ainsi qu'au-dessus.

**CAUTION:**

Do not operate the WaveDriver 200 in wet or damp conditions. Keep all instrument surfaces clean and dry.

ATTENTION:

N'utilisez pas l'appareil WaveDriver 200 dans un environnement mouillé et humide. Veillez à ce que toutes les surfaces de l'appareil soient toujours propres et sèches.

**CAUTION:**

Do not operate the WaveDriver 200 if it has suffered damage or is suspected of having failed. Refer the instrument to qualified service personnel for inspection.

ATTENTION:

N'utilisez pas l'appareil WaveDriver 200 s'il a été endommagé ou si vous pensez qu'il est tombé en panne. Signalez l'appareil au personnel d'entretien qualifié pour qu'il soit examiné.

**WARNING:**

Rotating shaft.

When connecting a WaveDriver 200 system to an electrode rotator other than the Pine Research MSR or WaveVortex 10 rotator, carefully consider the magnitude of the WaveDriver 200 rate control signal ratio (1 RPM/mV) and take steps to assure that the rotator is configured to use the same ratio.

Use extreme caution when operating the rotator at rotation rates above 2000 RPM.

AVERTISSEMENT:

Arbre tournant.

Lorsque vous connectez un système WaveDriver 200 à une électrode tournante autre que le MSR ou le WaveVortex 10 de Pine Research, prenez en compte soigneusement le rapport du signal de contrôle de vitesse du WaveDriver 200 (1 [tr/min]/mV) et assurez-vous que l'électrode tournante est configurée avec le même rapport.

Soyez extrêmement prudent lorsque vous utilisez l'électrode tournante à des vitesses de rotation supérieures à 2000 tr/min.

1.11 Electrostatic Discharge Information

Electrostatic discharge (ESD) is the rapid discharge of static electricity to ground. An ESD event occurs when two bodies of different potential approach each other closely enough such that static charge rapidly passes from one object to the next. Sensitive electronics in the path of the discharge may suffer damage. Damaging ESD events most often arise between a statically charged human body and a sensitive electronic circuit. The human body can easily accumulate static charge from simple movement from one place to another (*i.e.*, walking across a laboratory).

Potentiostat users must always be aware of the possibility of an ESD event and should employ good practices to minimize the chance of damaging the instrument. Some examples of good ESD prevention practices include the following:

- Self-ground your body before touching sensitive electronics or the electrodes. Self-grounding may be done by touching a grounded metal surface such as a metal pipe.
- Wear a conductive wrist-strap connected to a good earth ground to prevent a charge from building up on your body.
- Wear a conductive foot/heel strap or conductive footwear in conjunction with standing on a grounded conductive floor mat.
- Increase the relative humidity in the air to minimize static generation.

The WaveDriver 200 has been tested and found to be compliant with the European EMC product specific Standard EN 61326-1:2013 for immunity and emissions. The immunity standard includes testing for ESD to IEC 61000-4-2:2008.



INFO:

The WaveDriver 200 instrument may be susceptible to ESD events that occur on or near the electrode cable assembly. Such an ESD event can result in data loss, corruption of data, loss of communication with PC, and instrument unresponsiveness. Addition of a metallic shield to the electrode cable will improve the immunity of the system to an ESD event.

1.12 Hazardous Material Information

Disclosure tables in both English and Mandarin are provided (see Table 1-5 and Table 1-6) that detail information pertaining to the list of hazardous substances classified under the Restriction of Hazardous Substances Directive (RoHS).

Hazardous Material Disclosure Table						
AFP3						
Part Name	Hazardous Substances					
	Lead (Pb)	Mercury (Hg)	Cadmium (Cd)	Hexavalent Chromium (Cr (VI))	Polybrominated biphenyls (PBB)	Polybrominated diphenyl ethers (PBDE)
Analog PCB Assy.	X	○	○	○	○	○
Digital PCB Assy.	X	○	○	○	○	○
Frequency Response Analysis PCB Assy.	X	○	○	○	○	○
Dummy Cell Assy.	X	○	○	○	○	○

This table is prepared in accordance with the provisions of SJ/T 11364

○: indicates that said hazardous substance contained in all of the homogeneous materials for this part is below the limit requirements of GB/T 26572.

X: indicates that said hazardous substance contained in at least one of the homogeneous materials for this part is above the limit requirements of GB/T 26572.

Note: the date of manufacture for this item may be coded in the serial number as follows:
wwwyy5nn: ww indicates week; yy indicates year; and nn is the number of the item, starting with 01 each week.

Table 1-5. Hazardous Materials Disclosure (English)

有害物质披露表						
AFP3						
	铅	汞	镉	六价铬	多溴联苯	多溴二苯醚
	(Pb)	(Hg)	(Cd)	(Cr (VI))	(PBB)	(PBDE)
模拟电路板	X	○	○	○	○	○
数字电路板	X	○	○	○	○	○
频响分析电路板	X	○	○	○	○	○
虚拟电解池	X	○	○	○	○	○

本表格依据 SJ/T 11364 的规定编制。

○：表示该有害物质在该部件所有均质材料中的含量均在 GB/T 26572 规定的限量要求以下。

X：表示该有害物质至少在该部件的某一均质材料中的含量超出 GB/T 26572 规定的限量要求。

注：该部件的制造日期可能会按照以下格式出现在序列号码中：
wwwyy5nn：ww 表示周数；yy 表示年的最后两位数；nn 是该周序列号、每周都从01开始。

Table 1-6. Hazardous Materials Disclosure (Mandarin)

1.13 Software License

Purchase of a WaveDriver 200 instrument includes a license to use the AfterMath software package to control the instrument and analyze data collected using the instrument. Pine Research understands that the WaveDriver 200 is used in a laboratory environment where multiple computers are present and where data acquired using one computer might be analyzed using a different computer. The following software license describes how AfterMath may be used with the WaveDriver 200 in a laboratory with multiple computers.

PINE RESEARCH INSTRUMENTATION AFTERMATH DATA ORGANIZER SOFTWARE LICENSE

Pine Research Instrumentation, Inc. (hereafter "PINE") licenses purchasers (hereafter "LICENSEES") of Pine electrochemical potentiostats (hereafter "INSTRUMENTS") to use the AfterMath Data Organizer software (hereafter "SOFTWARE") in conjunction with these INSTRUMENTS. This License contains the terms and conditions of use of the SOFTWARE.

1. **Scope of License:** This License covers the software, user documentation and any related computer programs provided by PINE for use with one or more specific INSTRUMENTS. This License does not grant any proprietary or ownership rights in the SOFTWARE or related technology. The scope of this License is limited to an exclusive group of one or more specific INSTRUMENTS, where the members of this exclusive group are specifically enumerated and identified by make, model, and serial number at the time this License is purchased. The one or more specific INSTRUMENTS belonging to this exclusive group are hereafter referred to as the "DESIGNATED INSTRUMENTS".
2. **License:** PINE grants to LICENSEE a nonexclusive, nontransferable license to use the SOFTWARE in object code form on any computer which is connected to the DESIGNATED INSTRUMENTS for purposes of controlling the operation of the DESIGNATED INSTRUMENTS. The LICENSEE is not authorized to use the SOFTWARE to control the operation of any instruments other than the DESIGNATED INSTRUMENTS. PINE further grants to LICENSEE a nonexclusive, nontransferable license to use the SOFTWARE in object code form on up to five (5) other computers which are not connected to the DESIGNATED INSTRUMENTS for the sole purpose of analyzing data previously generated by the DESIGNATED INSTRUMENTS. PINE further grants permission to LICENSEE to make one (1) archival copy of the SOFTWARE for back-up purposes if required. Except as expressly authorized above, LICENSEE shall not: copy, in whole or in part, any of the SOFTWARE or documentation, modify the SOFTWARE, reverse engineer, reverse compile (de-compile), or reverse assemble all or any portion of the SOFTWARE, or rent, lease, distribute, sell or create derivative works of the SOFTWARE.
3. **Term and Termination:** The License hereby granted will continue in force until terminated, as set forth herein. If LICENSEE fails to pay any monies owed to PINE or its agents in connection with LICENSEE's purchase of the DESIGNATED INSTRUMENTS or this SOFTWARE, or violates any term of condition of this License, PINE or its agents may terminate this License immediately by giving notice of termination to LICENSEE.
4. **Limited Warranty:** PINE warrants the SOFTWARE to conform to the description of its function and performance. In the event that the SOFTWARE does not perform in accordance with this warranty, PINE agrees to repair or fix any non-conformity free of charge, or to refund any amount paid by LICENSEE for the SOFTWARE. Any modifications made to the SOFTWARE by LICENSEE shall void this warranty entirely.
5. **DISCLAIMER OF WARRANTY FOR SOFTWARE.** EXCEPT FOR THE EXPRESS WARRANTIES SET FORTH IN THIS AGREEMENT, PINE DISCLAIMS ALL IMPLIED WARRANTIES FOR THE SOFTWARE, INCLUDING WARRANTIES OF MERCHANTABILITY AND FITNESS FOR A PARTICULAR PURPOSE. PINE MAKES NO



REPRESENTATIONS CONCERNING THE QUALITY OF THE SOFTWARE AND DOES NOT PROMISE THAT THE SOFTWARE WILL BE ERROR FREE OR WILL OPERATE WITHOUT INTERRUPTION.

6. **LIMITATION OF LIABILITY.** IN NO EVENT WILL PINE BE LIABLE FOR ANY DIRECT, INDIRECT, INCIDENTAL, SPECIAL, CONSEQUENTIAL OR OTHER DAMAGES ARISING OUT OF THE USE OF OR INABILITY TO USE THE SOFTWARE BY ANY PERSON, REGARDLESS OF WHETHER PINE IS INFORMED OF THE POSSIBILITY OF DAMAGES IN ADVANCE. THESE LIMITATIONS APPLY TO ALL CAUSES OF ACTION, INCLUDING BREACH OF CONTRACT, BREACH OF WARRANTY, PINE'S NEGLIGENCE, STRICT LIABILITY, MISREPRESENTATION AND OTHER TORTS. In no event shall PINE's liability or liability of PINE's suppliers exceed the price paid by the LICENSEE for the SOFTWARE. The foregoing limitations shall apply even if the above-stated warranty fails of its essential purpose.
7. **Ownership of SOFTWARE:** PINE has and will retain all ownership rights in the SOFTWARE, including all patent rights, copyrights, trade secrets, trademarks, service marks, related goodwill and confidential and proprietary information. LICENSEE will have no rights in the SOFTWARE except as explicitly stated in this Agreement. Title to the SOFTWARE and documentation remains solely with PINE. LICENSEE may not assign this Agreement or any rights under it and may not delegate any duties under this Agreement without PINE's prior written consent. Any attempt to assign or delegate without such consent will be void.
8. **Confidential Information:** LICENSEE agrees that aspects of the SOFTWARE embody or constitute trade secrets and/or copyrighted material of PINE. LICENSEE agrees not to disclose, provide, or otherwise make available such trade secrets or copyrighted material in any form to any third party without the prior written consent of PINE. LICENSEE agrees to implement reasonable security measures to protect such trade secrets and copyrighted material.
9. **Applicable Law:** This License shall be governed by and construed in accordance with the laws of the State of Pennsylvania, United States of America, as if performed wholly within the State and without giving effect to the principles of conflict of law. If any portion hereof is found to be void or unenforceable, the remaining provisions of this License shall remain in full force and effect. This License constitutes the entire understanding and agreement between the parties with respect to the licensed use of the SOFTWARE.
10. **Modifications, Taxes:** Any modification of this Agreement must be in writing and signed by PINE and LICENSEE. Terms and conditions set forth in any purchase order which differ from, conflict with, or are not included in this Agreement, shall not become part of this License unless specifically accepted by PINE in writing. LICENSEE shall be responsible for and shall pay, and shall reimburse PINE on request if PINE is required to pay, any sales, use, value added (VAT), consumption or other tax (excluding any tax that is based on PINE's net income), assessment, duty, tariff, or other fee or charge of any kind or nature that is levied or imposed by any governmental authority on the SOFTWARE.

LICENSEE HAS READ THIS AGREEMENT AND UNDERSTANDS AND AGREES TO ALL OF ITS TERMS AND CONDITIONS.

2. Product Specifications

2.1 Instrument Description

The WaveDriver 200 is a benchtop instrument that is controlled by a personal computer (via a USB cable) using the AfterMath software package developed by Pine Research. The WaveDriver 200 may be operated as a potentiostat, a galvanostat, or as a bipotentiostat. The instrument is most often used to control the potential (or current) at one or two working electrodes located in an electrochemical cell along with a counter electrode and a suitable reference electrode. Popular DC electrochemical test methods (such as Cyclic Voltammetry, Chronoamperometry, Pulse and Square Wave Voltammetry, etc.) as well as AC methods (such as Electrochemical Impedance Spectroscopy) may be performed using the WaveDriver 200.

The working electrodes feature three potential ranges (± 2.5 V, ± 10.0 V, and ± 15.0 V) and eight current ranges (from ± 1.0 A down to ± 100.0 nA), making the WaveDriver 200 suitable for use with a wide variety of electrochemical cells. Because the WaveDriver 200 can control two independent working electrodes (*i.e.*, it can operate as a *two-channel potentiostat* or *bipotentiostat*), the instrument may be used with dual electrode configurations such as the rotating ring-disk electrode (RRDE).

2.2 Software Description

The AfterMath scientific data analysis and instrument control software developed by Pine Research is included with each WaveDriver 200 instrument. AfterMath offers several important benefits:

- **Instrument Control.** When started, AfterMath automatically detects all compatible instrumentation attached to the computer and provides complete control over each instrument. AfterMath can simultaneously control multiple instruments, and multiple experiments may be queued on each individual instrument. Even as new experiments are queued or running in the background, data acquired in previous experiments may be manipulated by the user.
- **Flexible Plotting.** AfterMath has a powerful "drag-n-drop" feature that allows traces from one plot to be quickly and easily copied and moved to other plots. Preparing an overlay plot from several voltammograms is straightforward. AfterMath provides precise control over line sizes, point markers, colors, axis limits, axis labels, and tick marks. One or more text boxes may be placed anywhere on a plot, and the text may be formatted with any combination of fonts, font sizes, or colors as desired.
- **Scientific Units.** Unlike graphing software designed for business and marketing applications, AfterMath is designed with scientific data in mind. Proper management of scientific units, metric prefixes, scientific notation, and significant figures are built into Aftermath. For example, if an operation divides a potential measured in millivolts by a current measured in nanoamperes, then Aftermath properly provides the result as a resistance measured in megaohms.
- **Data Archiving.** A unique and open XML-based file format allows data from several related experiments to be stored together in one single archive file. Keeping related experiments together in an archive file eliminates the need to manage multiple individual data files on the hard drive. The internal archive hierarchy can contain as many subfolders, reports, plots, notes, experimental parameters, and data sets as desired.
- **Tools and Transforms.** Flexible tools can be placed on any graph to precisely measure quantities like peak height and peak area. Multiple tools can be placed on a plot, and all such tools remain exactly where they are placed, even if the data archive is saved to a disk and reloaded at a later time. Fundamental mathematical operations (addition, multiplication, integration, logarithm, etc.) can be applied to any trace on any plot.

2.3 Instrument Specifications

The WaveDriver 200 instrument offers the following electrode control modes: potentiostatic (POT), galvanostatic (GAL), open circuit potential (OCP), and zero resistance ammeter (ZRA). Electrochemical impedance spectroscopy (EIS) may be performed in either potentiostatic or galvanostatic modes. Uncompensated resistance (Ru) measurement and compensation is available using both DC and AC techniques.



INFO:

All specifications provided in this section are subject to change without notice.

2.3.1 WaveDriver 200 Bipotentiostat/Galvanostat with EIS Specifications

ELECTRODE CONNECTIONS	
Reference Electrode	Sense line with driven shield
Counter Electrode	Drive line with grounded shield
First Working Electrode (K1)	Separate sense and drive lines, each with driven shield (current measurement via passive shunt)
Second Working Electrode (K2)	Separate sense and drive lines, each with driven shield (current measurement via transimpedance amplifier) Note: AC techniques are not available on K2.
GROUND CONNECTIONS	
DC Common (signal ground)	The DC Common is isolated from the USB port, the instrument chassis and earth ground. The DC Common is accessible via a banana jack (black) on the back panel.
Chassis Terminal	The instrument chassis terminal is accessible via a banana jack (metal) on the back panel. The GRAY banana plug on the cell cable also provides a chassis connection to allow convenient connection of the instrument chassis to a Faraday cage surrounding the electrochemical cell.
Earth Ground	No direct connection to earth ground is provided.

(specifications table is continued on the next page)

MEASURED CURRENT	
Ranges	± 1 A, ± 100 mA, ± 10 mA, ± 1 mA, ± 100 μ A, ± 10 μ A, ± 1 μ A, ± 100 nA
Resolution (at each range)	31.3 μ A, 3.13 μ A, 313 nA, 31.3 nA, 3.13 nA, 313 pA, 31.3 pA, 3.13 pA
Autoranging	Yes
Practical Range^s	5 pA to 1.0 A
DC Accuracy	$\pm 0.2\%$ of setting; $\pm 0.05\%$ of range
DC Leakage Current	< 10 pA at 25°C
AC Accuracy	Frequency- and range-dependent to 1 MHz
AC Leakage Current	Frequency- and range-dependent to 1 MHz
ADC Input	16 bits
Filters (for DC Experiments)	10 Hz, 30 Hz, 100 Hz, 1 kHz, 10 kHz (2-pole, low pass Bessel filters)
APPLIED CURRENT (GALVANOSTATIC MODE)	
Ranges	± 1 A, ± 100 mA, ± 10 mA, ± 1 mA, ± 100 μ A, ± 10 μ A, ± 1 μ A, ± 100 nA
Resolution (at each range)	31.3 μ A, 3.13 μ A, 313 nA, 31.3 nA, 3.13 nA, 313 pA, 31.3 pA, 3.13 pA
Accuracy	$\pm 0.2\%$ of setting; $\pm 0.05\%$ of range
DAC Output	16 bits
POWER AMPLIFIER (COUNTER ELECTRODE AMPLIFIER)	
Output Current	± 1.0 A (maximum)
Short Circuit Current Limit	1 A, 100 mA ranges: < 1.3 A 10 mA – 100 nA ranges: < 200 mA
Compliance Voltage	> ± 17 V
Bandwidth	> 2.5 MHz (on fastest speed setting)
Noise and Ripple	< 35 μ V _{RMS} in 2 MHz bandwidth
Slew Rate/Rise Time	10 V/ μ sec (on fastest speed setting)
ELECTROMETER (REFERENCE ELECTRODE AMPLIFIER)	
Input Impedance	> 10^{12} Ω in parallel with < 10 pF
Input Current	< 10 pA leakage/bias current at 25°C
CMRR	> 100 dB 0 – 1 kHz > 80 dB \leq 10 kHz > 60 dB \leq 100 kHz > 40 dB \leq 1 MHz
Bandwidth	> 15 MHz (3 dB)

(specifications table is continued on the next page)

MEASURED POTENTIAL	
Ranges	± 15.0 V, ± 10.0 V, ± 2.5 V
Resolution (at each range)	469 μ V, 313 μ V, 78 μ V per DAC bit
DC Accuracy	$\pm 0.2\%$ of setting, $\pm 0.05\%$ of range
ADC Input	16 bits
Filters (for DC Experiments)	10 Hz, 30 Hz, 100 Hz, 1 kHz, 10 kHz (2-pole, low pass Bessel filters)
APPLIED POTENTIAL (POTENTIOSTATIC MODE)	
Ranges	± 15.0 V, ± 10.0 V, ± 2.5 V
Resolution (at each range)	469 μ V, 313 μ V, 78 μ V per DAC bit
DC Accuracy	$\pm 0.2\%$ of setting, $\pm 0.05\%$ of range
DAC Output	16 bits
CV Sweep Rate (min)	10 μ V/s (469 μ V step per 46.9 s, 313 μ V step per 31.3 s, or 78 μ V per 7.8 s)
CV Sweep Rate (max)	75 V/s
DATA ACQUISITION (FOR DC EXPERIMENTS)	
Clock Resolution	10 ns (minimum time base)
Point Interval*	80 μ s (minimum)
Synchronization	Simultaneous sampling of all analog input signals
Raw Point Total	< 10 million per experiment
IMPEDANCE	
Frequency Range	10 μ Hz – 1MHz
Frequency Resolution	< 1 ppm 1 MHz – 100 mHz < 8 ppm 100 mHz – 10mHz < 90 ppm 10 mHz – 1 mHz < 700 ppm 1 mHz – 10 μ Hz
Frequency Stability	± 10 ppm
Modes	Potentiostatic/galvanostatic
Voltage Excitation Setpoint	1 mV – 200 mV peak, $\pm 10\%$ of setting
Current Excitation Setpoint	0.01% – 100% of current range, $\pm 10\%$ of setting, 200 mA max
Frequency Sweeping	Linear/logarithmic/custom list
Accuracy	See accuracy contour plot in Section 2.3.2

(specifications table is continued on the next page)

ROTATOR CONTROL CONNECTIONS (BACK PANEL)	
Connector A	7-pin mini circular DIN includes analog and digital signal grounds, digital rotator enable signal (+15 V max), auxiliary digital output signal, and analog rotation rate control signal
Connector B	3-pin connector includes analog signal ground, digital rotator enable signal (+15 V max), and analog rotation rate control signal
Rate Control Signal	$\pm 10.0 \text{ V}, \pm 2.5 \text{ V}$
Digital Enable Signal	Open drain with 4.7 k Ω pull up to +5 V (TTL compatible)
ACCESSORIES	
Dummy Cell	External dummy cell (included)
Cell Cable	Combination D-SUB connector to multiple banana plugs via shielded coaxial cables (included)
AUXILIARY CONNECTIONS (BACK PANEL)	
Connector C	9-pin DSUB connector that includes DC Common, two digital output signals, and two digital input signals
Trigger Input	BNC female, TTL compatible
Trigger Output	BNC female, TTL compatible
K1 Input and K2 Input	BNC female, $\pm 10 \text{ V}$ differential input, 20 k Ω impedance, $\pm 0.5\%$ accuracy; allows external waveform to be summed directly to the working electrode excitation signal
E1 Output	BNC female, $\pm 15 \text{ V}, \pm 10 \text{ V}, \pm 2.5 \text{ V}$ output, $\pm 0.5\%$ accuracy
I1 Output	BNC female, $\pm 10 \text{ V}$ output, scaled to current range, $\pm 0.5\%$ accuracy
E2 Output	BNC female, $\pm 15 \text{ V}, \pm 10 \text{ V}, \pm 2.5 \text{ V}$ output, $\pm 0.5\%$ accuracy
I2 Output	BNC female, $\pm 10 \text{ V}$ output, scaled to current range, $\pm 0.5\%$ accuracy
Auxiliary Analog Input	BNC female, $\pm 10 \text{ V}$ differential input, 313 μV resolution, 0.2% accuracy (available when second working electrode not in use)
Auxiliary Analog Output	BNC female, $\pm 10 \text{ V}$ bipolar output, 313 μV resolution, 0.2% accuracy (available when second working electrode not in use)

(specifications table is continued on the next page)

GENERAL SPECIFICATIONS	
Power Required	24.0 VDC ($\pm 5\%$), 5.0 A (low voltage DC device)
Power Supply	Input Requirements: 100 to 240 VAC, 1.4 to 0.7 A, 50 to 60 Hz Output Power: 24 VDC, 5.0 A Power supply (included) has a C14 type input connector
Power Cord	Various international cables sold separately (C13 type)
LED Indicators	Power, USB, and status
Instruments Dimensions	160 × 324 × 255 mm (6.3 × 12.75 × 10.0 in)
Instrument Weight	4.6 kg (10.2 lb)
Shipping Dimensions	254 × 356 × 457 mm (10 × 14 × 18 in)
Shipping Weight	7.7 kg (17 lb)
Temperature Range**	10°C to 40°C
Humidity Range	80% RH maximum, non-condensing

* Data acquisition using the minimum point interval is possible for short-duration bursts. The burst duration depends upon the available host PC USB bandwidth and is typically at least 3 s.

** It is recommended that the instrument primarily be used at or around room temperature (25°C). Varying operational temperature may affect accuracy.

§ The "practical range" of measurable currents goes from the maximum current output of the amplifier down to the current level at which noise begins to interfere with the signal. Using proper grounding, a cell shielded by a Faraday cage, and coaxial cell cables, it is possible to routinely measure signals as low as 5 pA.

2.3.2 EIS Accuracy Contour Plot

The ability of an Electrochemical Impedance Spectroscopy (EIS) instrument to make an accurate impedance measurement varies with both the frequency of interest and the actual load being measured. An Accuracy Contour Plot (ACP) provides a visual tool for understanding the EIS measurement accuracy limits for a particular instrument. The ACP maps out the range of available excitation frequencies along the horizontal axis and the range of measurable loads along the vertical axis (see Figure 2-1).

Various regions of the ACP plot are marked (usually by shading with different colors) with each region representing a different level of accuracy. For any given excitation frequency and load, the corresponding point can be located on the ACP, and the particular region in which the point falls indicates the expected accuracy of the EIS measurement.

The ACP for the WaveDriver 200 (see Figure 2-1) shows three regions of accuracy. The large, inner, conically-shaped region (which is shaded blue) indicates the wide range of frequencies and loads where the WaveDriver 200 can accurately measure the complex impedance magnitude to within one percent ($\pm 1.0\%$) and the complex impedance phase angle to within one degree ($\pm 1.0^\circ$).

Two smaller and thinner regions on the ACP (one shaded green and the other shaded yellow) show where an EIS measurement becomes less accurate. The green region shows where the WaveDriver 200 can measure the impedance magnitude to within two percent ($\pm 2.0\%$) and the phase angle to within two degrees ($\pm 2.0^\circ$). The yellow region shows where the impedance magnitude can be measured to within five percent ($\pm 5.0\%$) and the phase angle to within five degrees ($\pm 5.0^\circ$).

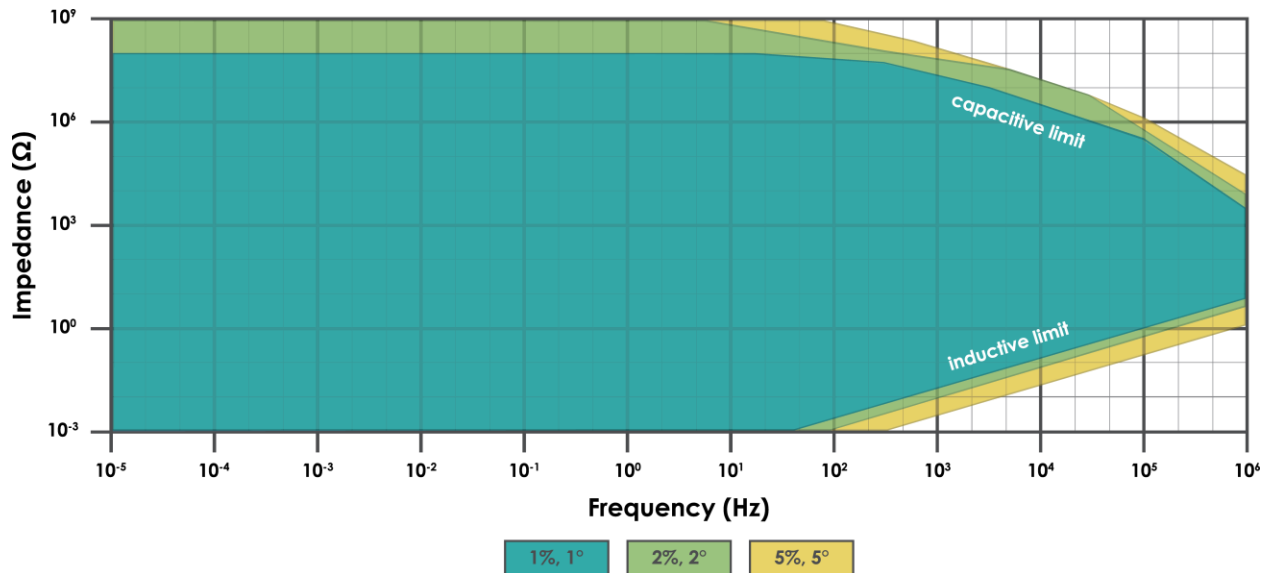

Figure 2-1. WaveDriver 200 Bipotentiostat/Galvanostat EIS Accuracy Contour Plot

When working at high frequencies with large loads, the measurement accuracy is limited by the influence of stray capacitance in the system. (The system includes the electrochemical cell, the electrodes, the cable connections to the electrodes, and the measurement circuitry within the instrument itself.) This capacitive limit is readily observable on the ACP (see the upper-right part of Figure 2-1) where regions of lower accuracy appear as diagonal bands sloping downwards going towards higher frequencies.

When working with high frequencies and small loads, the measurement accuracy is limited not by stray capacitance, but rather by stray inductance in the system. The inductive limit is also readily observable on the ACP (see the lower-right part of Figure 2-1) where regions of lower accuracy appear as diagonal bands sloping upwards going towards higher frequencies.

The WaveDriver 200 ACP is based upon EIS measurements made under ideal conditions (i.e., Faraday cage connected to instrument chassis, proper orientation of cell cables, floating DC Common, standard length cell cable) using known loads (precision resistors and capacitors) to probe the accuracy of measurements near the capacitive and inductive limits. The majority of the ACP (loads greater than 100 m Ω) is based upon potentiostatic EIS measurements (10 mV_{RMS}). The lower portion of the ACP (loads less than or equal to 100 m Ω) is based upon galvanostatic EIS measurements (100 mA_{RMS}).

There are many factors that may affect the accuracy of an EIS measurement, such as the grounding/shielding configuration (see Section 6), the cell cable arrangement (see Section 4.6.1), and the choice of EIS experimental parameters (amplitude, filters, etc.). Particular care and attention to detail is required when making (and interpreting) EIS measurements at frequencies above 100 kHz.

2.4 Standard Electrochemical Methods

The WaveDriver 200 bipotentiostat together with the AfterMath software package can perform many electrochemical techniques (see Table 2-1). Further descriptions about how to configure and execute these techniques can be found in AfterMath software documentation.

Simple Methods	Rotating Disk Methods
Open Circuit Potential (OCP)	Rotating Disk Electrode (RDE)
Constant Potential Electrolysis (BE)	Koutecky-Levich Series (KL-RDE)
Constant Current Electrolysis (BE)	Rotating Disk Electrolysis (BE-RDE)
Zero Resistance Ammeter (ZRA)	Rotating Disk Chronopotentiometry (CP-RDE)
Voltammetric Methods	Rotating Disk Ramp Chronopotentiometry (RCP-RDE)
Cyclic Voltammetry (CV)	Rotating Ring-Disk Methods
Linear Sweep Voltammetry (LSV)	Rotating Ring-Disk Voltammetry (RRDE)
Staircase Voltammetry (SCV)	Rotating Ring-Disk Koutecky-Levich (KL-RRDE)
Chronoamperometry (CA)	Rotating Ring-Disk Electrolysis (BE-RRDE)
Normal Pulse Voltammetry (NPV)	Corrosion Methods
Cyclic Step Chronoamperometry (CSCA)	Linear Polarization Resistance (LPR)
Differential Pulse Voltammetry (DPV)	Rotating Cylinder Voltammetry (RCE)
Square-Wave Voltammetry (SWV)	Rotating Cylinder Electrolysis (BE-RCE)
Double Potential Step Chronoamperometry (DPSCA)	Rotating Cylinder Eisenberg Study (EZB-RCE)
Galvanostatic Methods	Rotating Cylinder Polarization Resistance (LPR-RCE)
Chronopotentiometry (CP)	Rotating Cylinder Open Circuit Potential (OCP-RCE)
Ramp Chronopotentiometry (RCP)	Rotating Cylinder Chronopotentiometry (CP-RCE)
Staircase Potentiometry (SCP)	Rotating Cylinder Ramp Chronopotentiometry (RCP-RCE)
Cyclic Step Chronopotentiometry (CSCP)	Uncompensated Resistance Methods
Stripping Voltammetry	Current Interrupt (CI-RU)
Anodic & Cathodic Stripping Voltammetry (ASV)	Positive Feedback (PF-RU)
Differential Pulse Stripping Voltammetry (DPSV)	Impedance RU (EIS-RU)
Square-Wave Stripping Voltammetry (SWSV)	Electrochemical Impedance Spectroscopy
Spectroscopic Methods*	Potentiostatic Electrochemical Impedance Spectroscopy (EIS-POT)
Spectroscopy (SPEC)	Galvanostatic Electrochemical Impedance Spectroscopy (EIS-GAL)
Spectroelectrochemistry (SPECE)	Rotating Disk Electrochemical Impedance Spectroscopy (EIS-RDE)
Dual Electrode Methods	Mott-Schottky (EIS-MOTT)
Dual Electrode Electrolysis (DEBE)	
Dual Electrode Voltammetry (DECV)	

Table 2-1. Electrochemical Techniques in AfterMath

*Access to these electrode methods requires a separate software license. If you have an Avantes spectrometer and would like to access these experiments, please contact Technical Service for assistance (see Section 1.6).



TIP:

More information about configuring electrochemical techniques using AfterMath may be found by searching our knowledgebase.

<https://www.pineresearch.com/shop/knowledgebase/>

2.5 System Components

The WaveDriver 200 bipotentiostat system, as shipped from the production facility, includes all parts, cables, and software necessary for its initial use (see Table 2-2).







	
	
	
1 Instrument	WaveDriver 200 Bipotentiostat/Galvanostat with EIS
2 USB Flash Drive	Contains AfterMath software, drivers, and license files
3 Cell Cable	General purpose cell cable with six coaxial electrode cables and one instrument chassis connector (see Section 5 for details)
4 Pine Research Universal Dummy Cell	A network of test and calibration circuits used to calibrate and verify proper instrument operation (see Section 2.8 for details)
5 Power Supply	Input Requirements: 100 to 240 VAC, 1.4 to 0.7 A, 50 to 60 Hz Output Power: 24 VDC, 5.0 A Power supply (included) has a C14 type input connector compatible with a variety of international power cords (sold separately, see Section 7)
6 Interface (USB) Cable	Communication cable between computer and WaveDriver 200 (USB type A male to type B male)

Table 2-2. Main Components Included with WaveDriver 200 Bipotentiostat

2.6 Front Panel

The front panel of the WaveDriver 200 has three LED indicators, the power switch, the cell cable port, and a logo indicating Pine Research as the manufacturer of the instrument (see Table 2-3). The three LEDs indicate power, communications activity (USB), and overall instrument status. Various colors and blink patterns are used by the LED indicators (see Table 2-4).

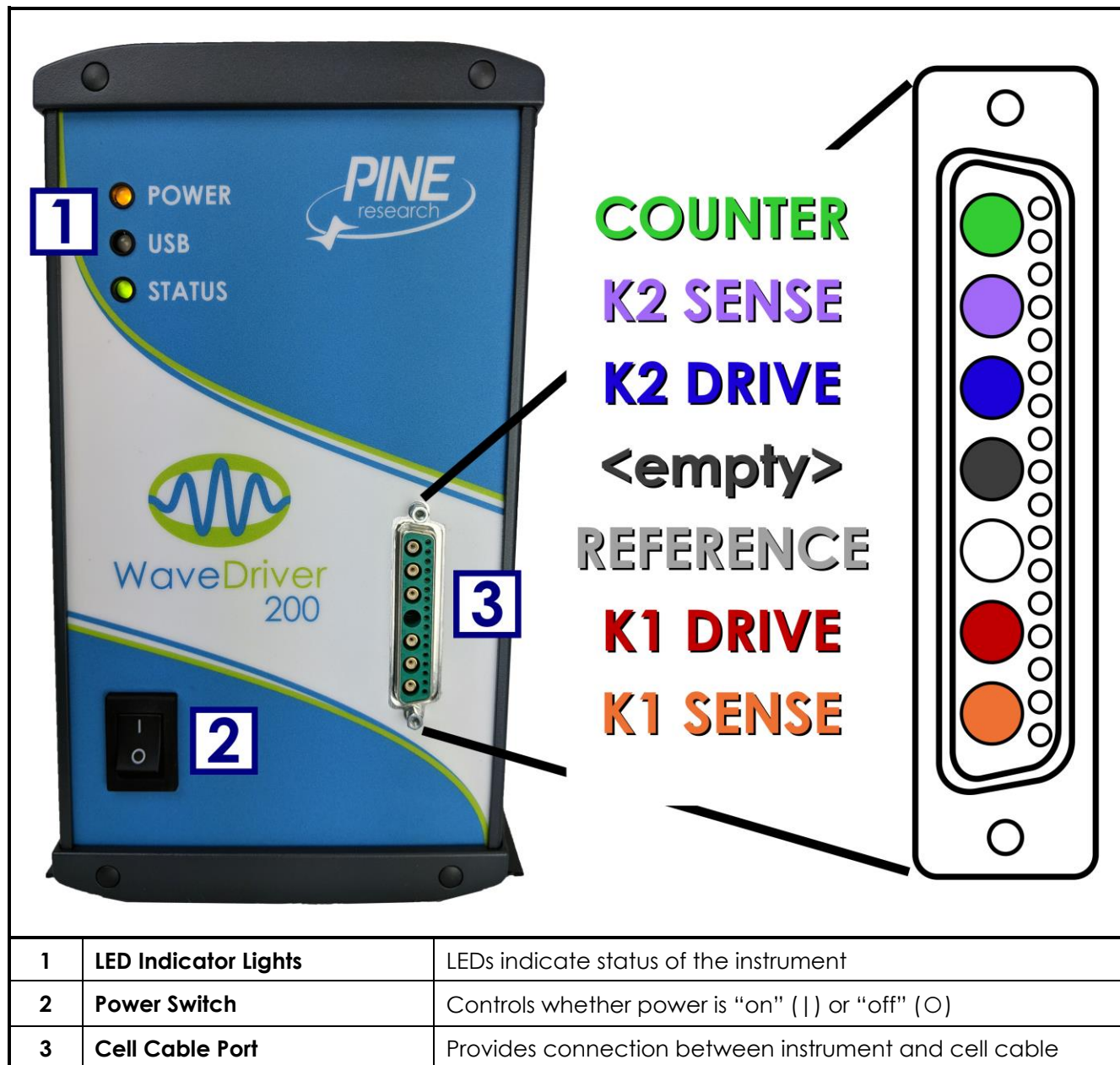

Table 2-3. Front Panel of the WaveDriver 200 Bipotentiostat







LED	LED Color/State	Indication
Power	 not illuminated	When the power LED is not illuminated, the instrument power switch is in the "off" position (or the power supply is not providing power).
	 solid yellow	When the power LED is solid yellow, the power supply is providing power to the instrument and the power switch is in the "on" position.
USB	 blinking green	When the USB LED is blinking (or flickering), data transfer is occurring between the instrument and the computer.
	 not illuminated	When the USB LED is not illuminated, no data is being transferred between the instrument and computer.
Status	 slow blinking green	When the status LED is green and blinking slowly (one second illuminated, one second not illuminated), successful communication has occurred between the instrument and the AfterMath software, and the instrument is presently idle (<i>i.e.</i> , not performing an experiment).
	 fast blinking green	When the status LED is green and blinking quickly (half second illuminated, half second not illuminated), the instrument is performing an experiment.
	 blinking orange	When the status LED is orange and blinking, the instrument is performing a self-test (immediately after being powered on), or the instrument is waiting for the AfterMath software to establish initial communication with the instrument.
	 solid or blinking red	When the status LED is red (either blinking or solid), there is a serious problem with the instrument. Contact Technical Service for assistance (see Section 1.6).

Table 2-4. Overview of WaveDriver 200 Bipotentiostat LED Indicator Lights

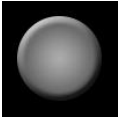
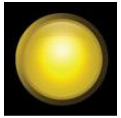
2.7 Back Panel

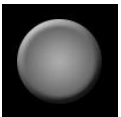
The back panel of the WaveDriver 200 features several input and output connections to facilitate connection to other instruments and devices (see Figure 2-2 and Table 2-5 below). Pinouts for the three control ports (labeled "A", "B", and "C" in the "CONTROL PORTS" box on the back panel – see Figure 2-2) are also provided (see Figure 2-3). Control ports A and B are specifically designed to control an electrode rotator, while control port C is a non-specific digital control port.

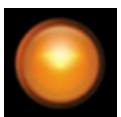
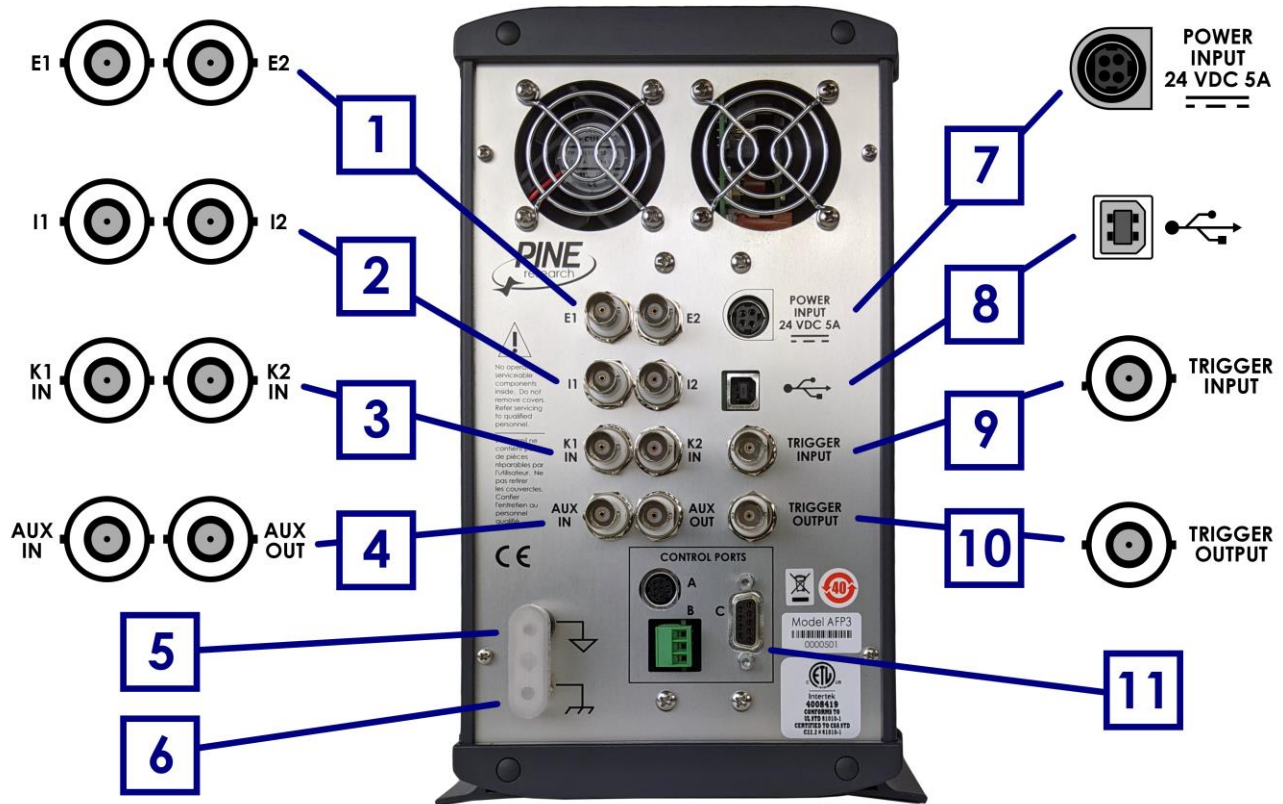

Figure 2-2. WaveDriver 200 Back Panel Connections

1	E1	BNC female, potential output from first working electrode (K1)
	E2	BNC female, potential output from second working electrode (K2)
2	I1	BNC female, current output from first working electrode (K1)
	I2	BNC female, current output from second working electrode (K2)
3	K1 IN	BNC female, ± 10 V differential input, 20 k Ω impedance, $\pm 0.5\%$ accuracy; sums an external waveform to first working electrode (K1)
	K2 IN	BNC female, ± 10 V differential input, 20 k Ω impedance, $\pm 0.5\%$ accuracy; sums an external waveform to the second working electrode (K2)
4	AUX IN	BNC female, ± 10 V differential input, 313 μ V resolution, 20 k Ω impedance, 0.2% accuracy; available only when K2 electrode not in use
	AUX OUT	BNC female, ± 10 V bipolar output, 313 μ V resolution, 0.2% accuracy; available only when K2 electrode not in use
5	DC Common Terminal	 Banana jack (black) that provides a secure connection to DC Common (signal ground)
6	Chassis Terminal	 Banana jack (metal) that provides a secure connection to the chassis of the instrument
7	Power Input	A low voltage (24.0 VDC, 5.0 A) power input connector
8	USB Input	USB jack (type B) for computer communication
9	Trigger Input	BNC female, TTL compatible
10	Trigger Output	BNC female, TTL compatible
11	Rotator Control Port A	7-pin mini-DIN input for rotator control – includes analog and digital signal grounds, digital rotator enable signal (+15 V max), auxiliary digital output signal, and analog rotation rate control signal
	Rotator Control Port B	3-pin terminal block connector for rotator control – includes analog signal ground, digital rotator enable signal (open drain – TTL compatible, +15 V max), and analog rotation rate control signal (± 10 V, ± 2.5 V)
	Digital Port C	9-pin D-Sub connector that includes digital signal ground, two digital output signals, and two digital input signals

Table 2-5. WaveDriver 200 Back Panel Connector Descriptions



Pin	Signal	Pin	Signal
A1	Unused	B3	Digital rotator enable signal
A2	Auxiliary digital output signal	C1	Unused
A3	Unused	C2	Digital signal input 2
A4	Analog rotation rate control signal	C3	Digital signal input 3
A5	Digital signal ground	C4	Digital signal output 2
A6	Unused	C5	Digital signal output 3
A7	Digital rotator enable signal	C6	+5 V digital output
A8	Analog signal ground	C7	Digital signal ground
B1	Analog rotation rate control signal	C8	Digital signal ground
B2	Analog signal ground	C9	Digital signal ground

Figure 2-3. WaveDriver 200 Control Ports A, B, and C Pinouts

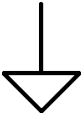
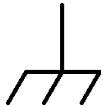
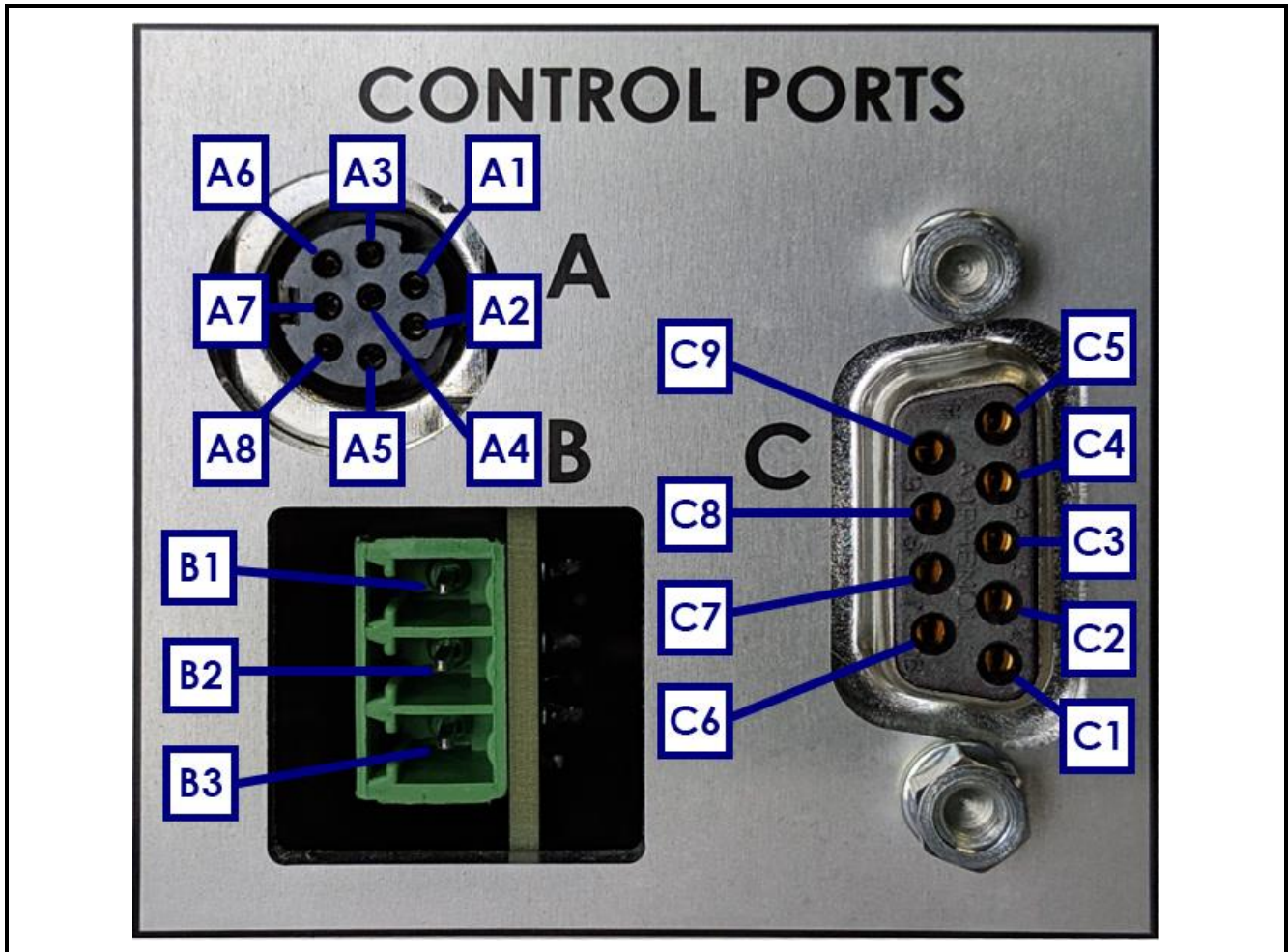
2.8 Dummy Cell Description

A dummy cell is a network of known resistors, capacitors, and inductors that can be used to test and/or calibrate a potentiostat to ensure that it is working properly. The Pine Research Universal Dummy Cell included with the WaveDriver 200 contains three separate circuit networks (see Figure 2-4).

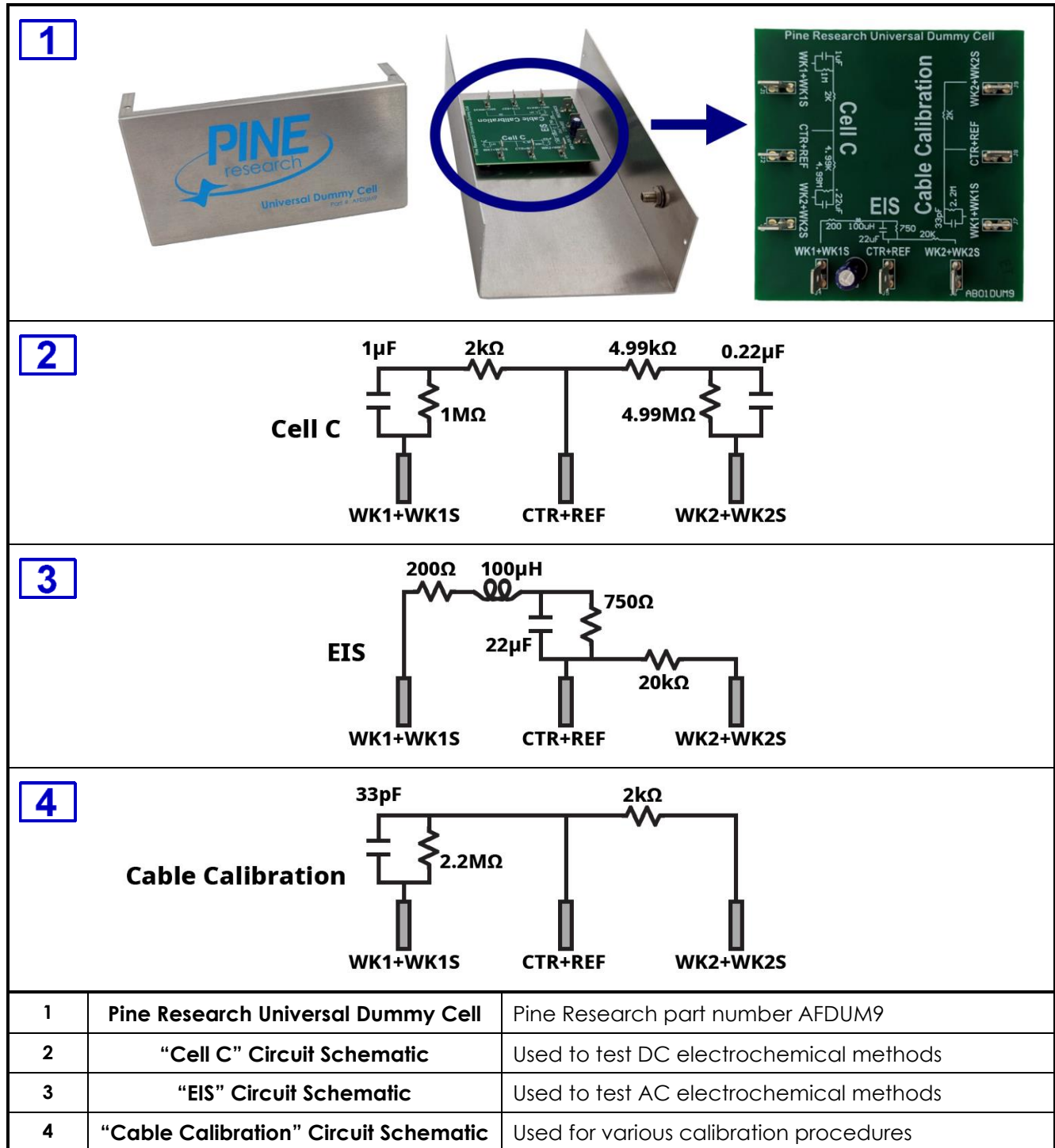

Figure 2-4. WaveDriver 200 Pine Research Universal Dummy Cell (with Schematic Diagrams)

The circuit for "Cell C" of the dummy cell is used for testing the DC capabilities of the WaveDriver 200. The circuit for "EIS" contains resistors, a capacitor, and an inductor. This circuit provides a predictable EIS response that can be used to verify the AC behavior of the instrument. The results are also useful for learning how to use the EIS circuit fitting feature in the AfterMath software (see Section 4.7). The "Cable Calibration" circuit on the dummy cell is a special circuit that is used to calibrate the cell cable capacitance (see Section 4.4).

**NOTE:**

If using a WaveDriver 200 purchased before November 2020, a different dummy cell was included (Pine Research part number AFDUM5). See Section 10 for information on this legacy dummy cell.

**TIP:**

Contact Technical Service for assistance if you have any questions or concerns regarding the use of the Pine Research Universal Dummy Cell (see Section 1.6).

3. System Installation

Setting up the WaveDriver 200 system in a laboratory consists of three basic steps: (1) physical installation, (2) software installation, and (3) system testing and cell cable calibration. The entire process usually requires about sixty minutes. The physical and software installation steps are described in this section (below), and the system testing and cell cable calibration procedures are described in the next section (see Section 4).

3.1 Physical Installation

The WaveDriver 200 is a benchtop instrument designed for use in a typical laboratory environment. Physical installation involves positioning the instrument and the computer that controls the instrument in a suitable location and connecting the instrument to a source of electrical power (*i.e.*, the AC Mains) and to the computer via a USB cable.

3.1.1 Location

The instrument should be placed on a sturdy lab bench or table in such a way that there is unobstructed access to the instrument's front panel; this ensures space for the cell cable connection and allows the user to easily operate the power switch and see the LED lights. There should also be at least two inches (50 mm) of clearance around the sides (left, right, and back) and above (top) the instrument. Particular care should be given to selecting a clean and dry location. The vent fans on the back panel must not be blocked so that adequate ventilation is available for cooling the circuitry inside the instrument.

During normal use, the instrument is connected to an electrochemical cell via a cell cable plugged into the front panel of the instrument. Thus, it is important to ensure that the lab bench or table also has sufficient workspace for securely mounting the electrochemical cell and for routing the cell cable between the instrument and the electrochemical cell.

3.1.2 Glovebox Installation

There are two practical ways to perform electrochemical experiments inside of a glovebox. Both require that the glovebox be equipped with special cable feedthroughs.

Potentiostat and Electrochemical Cell in Glovebox. Placing the instrument and the electrochemical cell inside the glovebox is by far the easiest and preferred approach. By keeping the instrument close to the cell, the cell cables are shorter, minimizing interference from environmental noise sources. A special USB feedthrough port is required for this approach. This allows the computer controlling the instrument to remain outside the glovebox with only the USB communication signals passing through the wall of the glovebox. Inexpensive third-party USB cable feedthroughs are available (see Figure 3-1) that fit into the standard KF-style flanges commonly found on gloveboxes. Many Pine Research customers have successfully used feedthroughs offered by the Kurt J. Lesker Company (www.lesker.com).

The instrument may be transferred into the glovebox by passing it through the glovebox antechamber. Any cables, power cords, or instrument accessories are also safe to bring into the glovebox through the antechamber. When ramping the antechamber down to vacuum, a gradual approach should be taken to prevent damage to instrument circuitry. The exact time needed to fully remove any residual air from the potentiostat and accessories varies by antechamber size and vacuum strength. While it is recommended to follow established glovebox user protocols, it is also suggested that the amount of time the instrument is exposed to vacuum be as short as possible. Once inside the glovebox, operation of the potentiostat is identical to outside the glovebox, though some signal noise may be introduced by

the glovebox environment (vacuum pumps, gas valve actuators, vibrations, etc.). Once the instrument is placed inside the glovebox, it is a good idea to leave it in the glovebox; repeated cycling through the antechamber is not recommended.



Copyright © Kurt J. Lester Company. Used with permission.



Figure 3-1. USB Cable Glovebox Feedthrough



Figure 3-2. Cell Cable Glovebox Feedthrough

Electrochemical Cell Only in Glovebox. If the potentiostat must remain outside the glovebox, then it is possible to feed a longer version of the cell cable through a port in the wall of the glovebox. A port with a KF-40 flange is ideal, and epoxy can be used to seal around the individual cell cable lines as they pass through the flange (see Figure 3-2). To mitigate any signal noise picked up by the longer cell cable, an electrically conductive and earth grounded mesh may need to be installed around the cell cable bundle. Additionally, using a longer cell cable is likely to reduce the performance of the instrument when making EIS measurements. Specifically, the longer cell cables introduce additional stray capacitance into the measurement system and this is likely to reduce the accuracy of EIS measurements, particularly at higher frequencies (see Section 2.3.2 for a discussion of EIS accuracy).

3.1.3 Connecting the Power Supply to the Instrument



Figure 3-3. Power Supply with Low Voltage (24 VDC) Cable Connection to Back Panel

The power supply provides the DC power required by the instrument (24 VDC, 5.0 A) via a low voltage cable. One end of the low voltage cable is permanently connected to the power supply, and the other end is connected to the POWER INPUT port located on the back panel of the instrument (see Figure 3-3).



CAUTION:

Use proper cable connector orientation.

One side of the low voltage cable connector has a flat surface. When inserting this connector into the POWER INPUT port, the flat surface of the connector must be oriented toward the right (i.e., towards the words "POWER INPUT" printed on the back panel)

ATTENTION:

Utilisez l'orientation convenable du câble connecteur.

Un côté du câble connecteur basse tension a une surface plane. Lors de l'insertion de ce connecteur dans le port d'alimentation (POWER INPUT), la surface plane du connecteur doit être orientée vers la droite (c'est-à-dire vers les mots "POWER INPUT" imprimés sur le panneau arrière).

When connecting the low voltage power cable to the POWER INPUT port on the back panel, take note that the connector will only fit into the port using one particular orientation. The side of the cable connector that is completely flat must be oriented to the right when plugging the connector into the port.

When properly installed, the low voltage power cable will securely latch into the POWER INPUT port. When unplugging the low voltage power cable from the port, it is important to release this latch correctly. Grip the connector firmly near the flat part of the connector. Then, pull the connector straight out (do not twist the connector).

3.1.4 Connecting the Power Supply to the AC Mains

The WaveDriver 200 power supply is connected to the AC Mains via an AC power cord. The AC power cord must be rated to carry at least 10 Amps. One end of the AC power cord is connected to the standard C14 connector on the power supply, and the other end is connected to the AC Mains (wall outlet). Pine Research offers power cords suitable for use in a variety of different countries and regions (see Section 7).

The local source of electrical power (*i.e.*, the AC Mains) must be a branch circuit protected by a circuit breaker rated between 10 and 15 Amps. The AC voltage supplied by the AC Mains must be between 100 and 240 VAC, and the AC frequency must be between 50 and 60 Hz. The power supply and AC power cord must be positioned such that the user has unobstructed access to these items. The user must be able to disconnect the instrument from the power supply and disconnect the power supply from the AC mains (wall outlet) without any obstructions.



CAUTION:

Connect the Power Supply to the AC mains using the Power Cord supplied with the WaveDriver 200 and certified for the country of use (see Section 7 of this User Guide for more details).

ATTENTION:

Connectez le bloc d'alimentation au secteur à l'aide du cordon d'alimentation fourni avec l'appareil WaveDriver 200 et conforme aux réglementations du pays d'utilisation (pour plus de détails, consultez la partie 7 du présent mode d'emploi).



CAUTION:

Do not block access to the Power Supply or its cord. The user must have access to disconnect the Power Supply or the Power Cord from the AC mains at all times.

ATTENTION:

Ne bloquez pas l'accès au bloc d'alimentation ou son cordon. L'utilisateur doit être en mesure de déconnecter le bloc d'alimentation ou le cordon d'alimentation du secteur à tout moment.



CAUTION:

The Power Switch located on the front panel of the instrument disconnects the instrument from the power source. Do not block access to the Power Switch. The user must have access to the Power Switch at all times.

ATTENTION:

L'interrupteur d'alimentation situé sur le devant de l'appareil permet de couper l'alimentation. Ne bloquez pas l'accès à l'interrupteur. L'utilisateur doit avoir accès à l'interrupteur à tout moment.

3.2 AfterMath Software Installation



STOP:

Do not use the USB cable to connect the WaveDriver 200 to the computer until after the software and driver installation are complete. It is important to first install AfterMath and the associated device driver software so that Microsoft Windows can properly detect the instrument.

AfterMath is a software package designed to run on a personal computer using the Windows® operating system. The minimum system requirements for the personal computer and operating system are listed below (see Table 3-1).

Processor Speed	1 GHz (32-bit or 64-bit processor) minimum
Physical Memory	2 GB minimum recommended RAM; 4 GB minimum (for 32-bit processor) or 6 GB (for 64-bit processor) preferred
Screen Resolution	1024 x 768 pixels or greater required
Operating System	Windows 7 (32 or 64 bit), Windows 8 (32 or 64 bit), Windows 10 (32 or 64 bit)
USB Port	USB 2.0 must be available
Prerequisite Software	Microsoft .NET Framework (version 4.0) Microsoft Visual C++ Runtime Library (version 8.0)

Table 3-1. Computer System Requirements for AfterMath Software

Note that the prerequisite software (Visual C++ runtime and .NET Framework) is often already present on modern personal computers. If they are missing from the computer, these components are available for free download from the Microsoft website. Up-to-date AfterMath and Microsoft Corporation download links are maintained on the Pine Research knowledgebase website.



TIP:

The most up-to-date versions of the software required to operate the WaveDriver 200 instrument may be found on the Pine Research knowledgebase at the following address:

<https://www.pineresearch.com/shop/knowledgebase/>

3.2.1 Step-by-Step Software Installation Instructions

AfterMath installation media is included with the WaveDriver 200. The installation media contains the latest release of AfterMath available at the time of purchase, the device drivers for communicating with the instrument, and the permissions files that implement the software license.

The installation media contains a file called "**setup.exe**". Launch this executable file and follow the instructions on the screen. Screenshots of a typical installation are provided below (see Figure 3-4 through Figure 3-14).

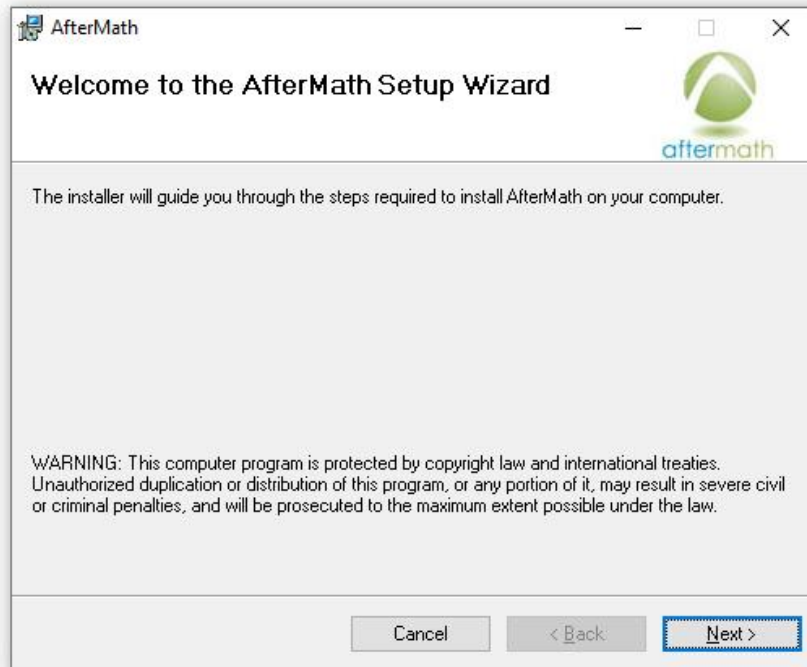

Figure 3-4. Welcome to AfterMath Setup Wizard Dialog Box

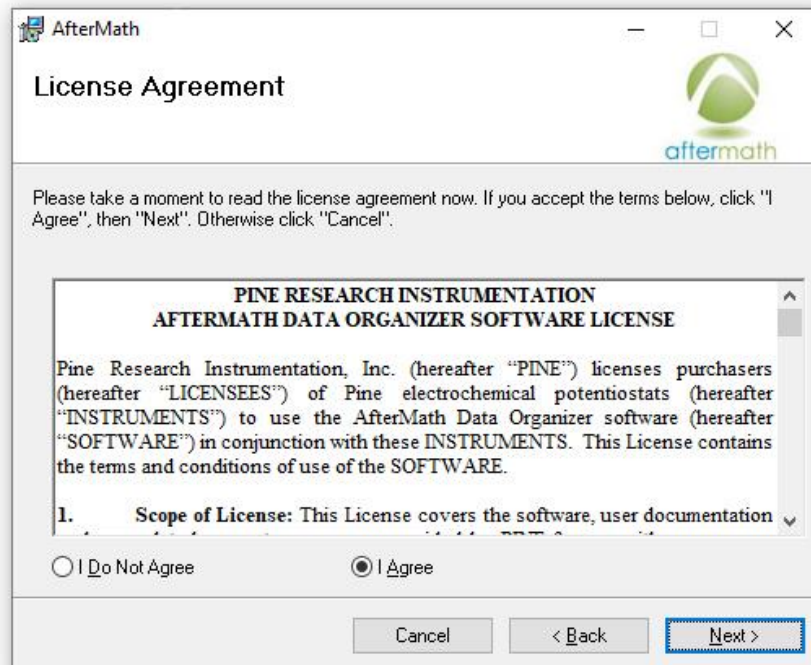

Figure 3-5. AfterMath Installation License Agreement

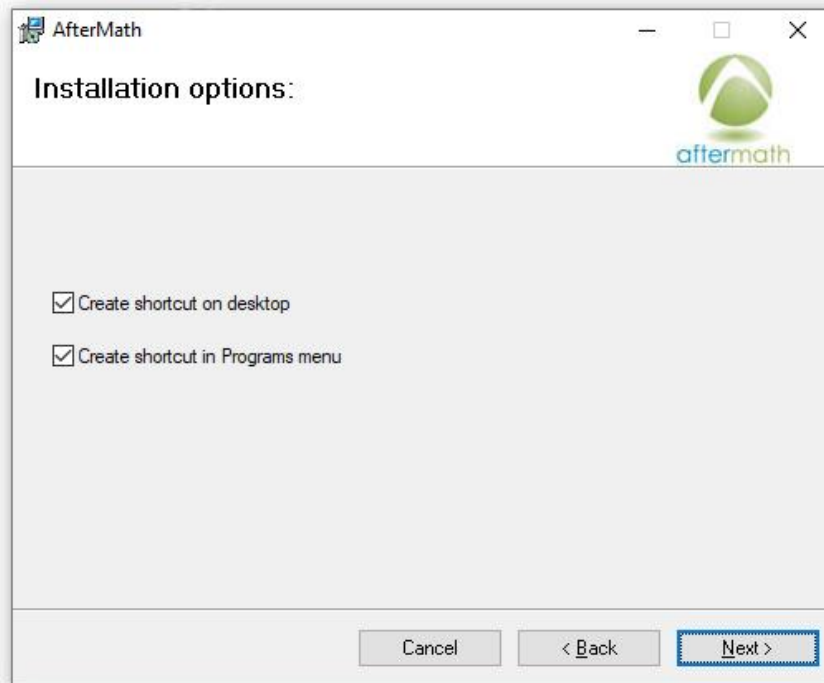

Figure 3-6. AfterMath Installation Options

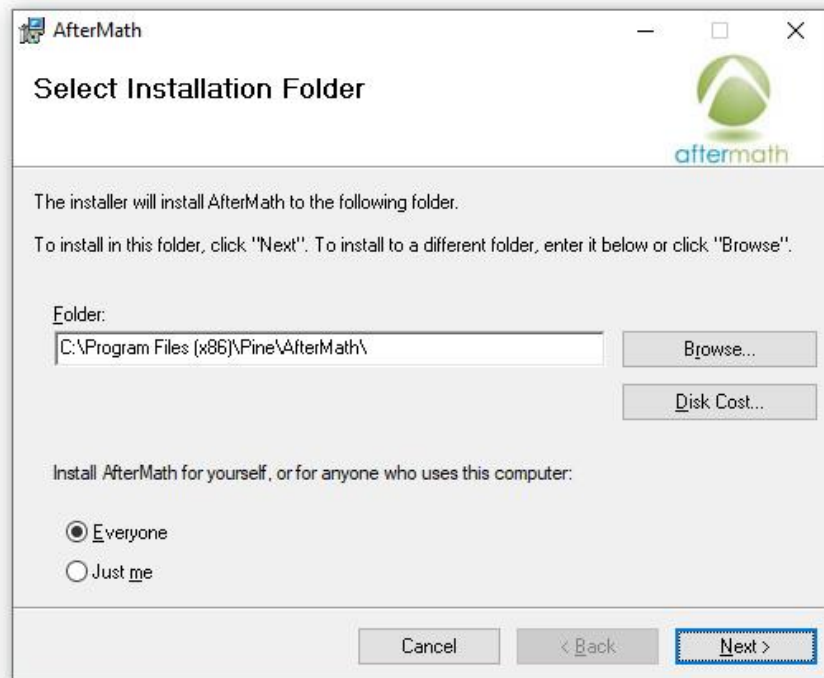

Figure 3-7. Selecting AfterMath Installation Folder and User Access

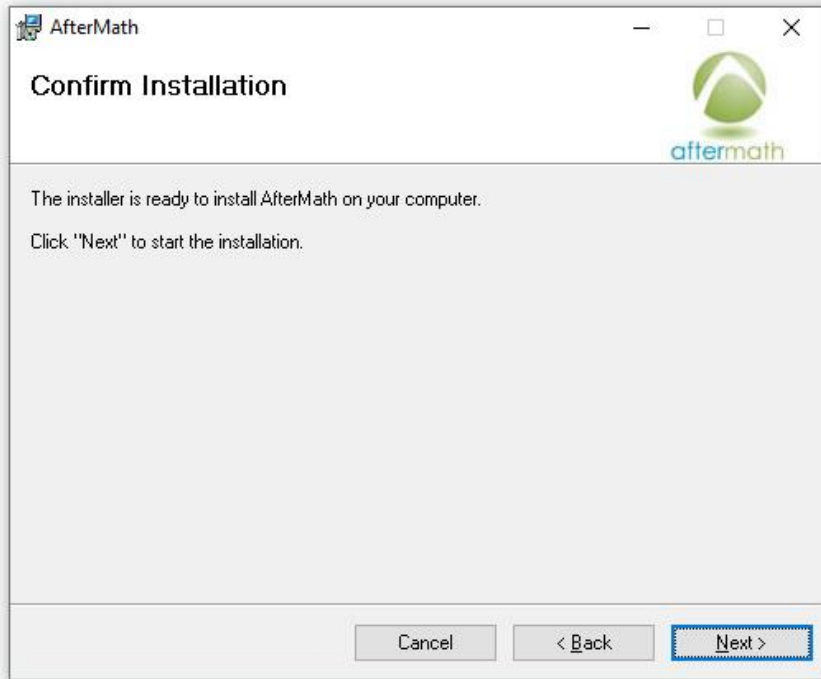

Figure 3-8. Confirm Installation of AfterMath

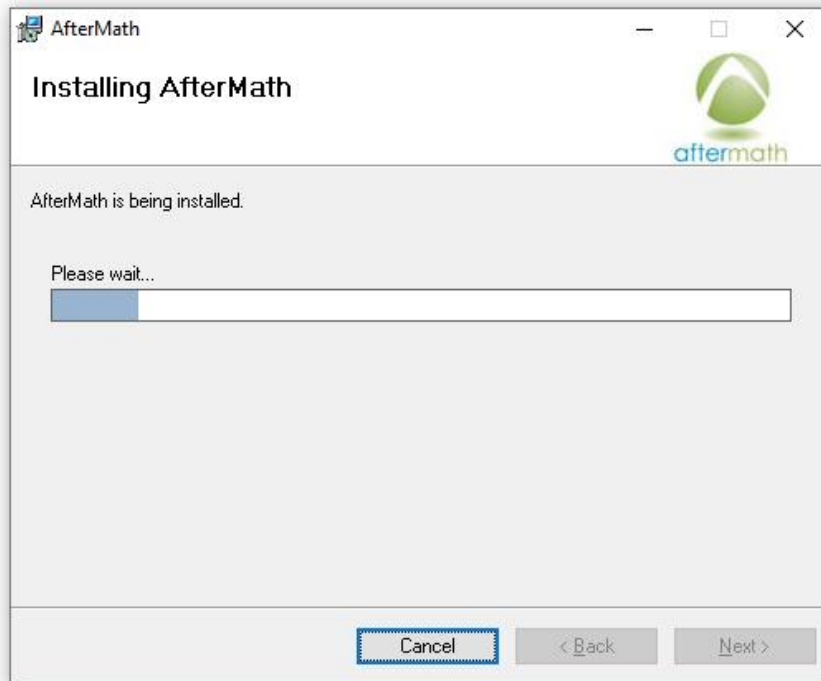

Figure 3-9. Installation Progress of AfterMath

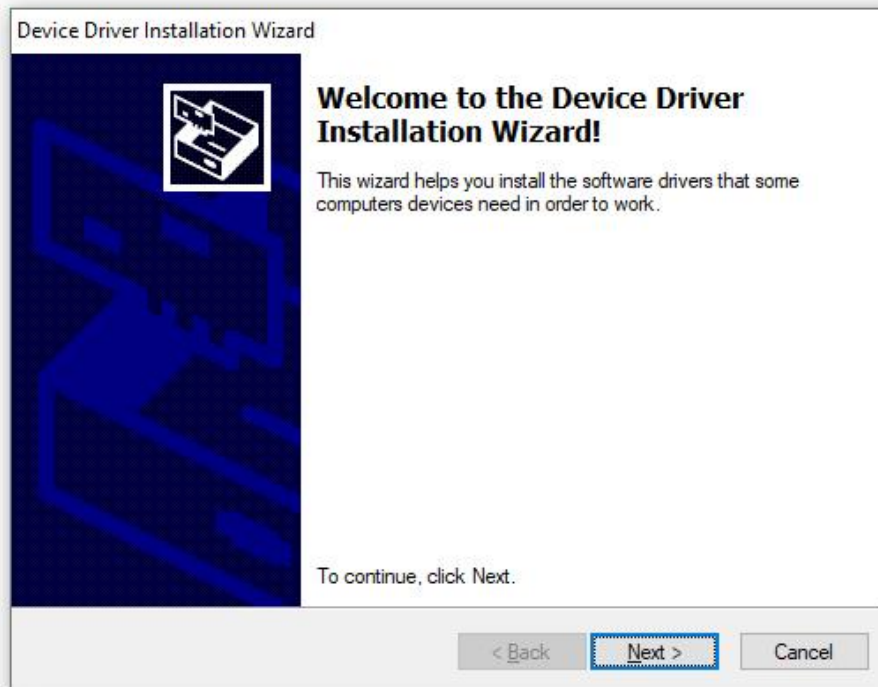

Figure 3-10. Device Driver Installation Wizard

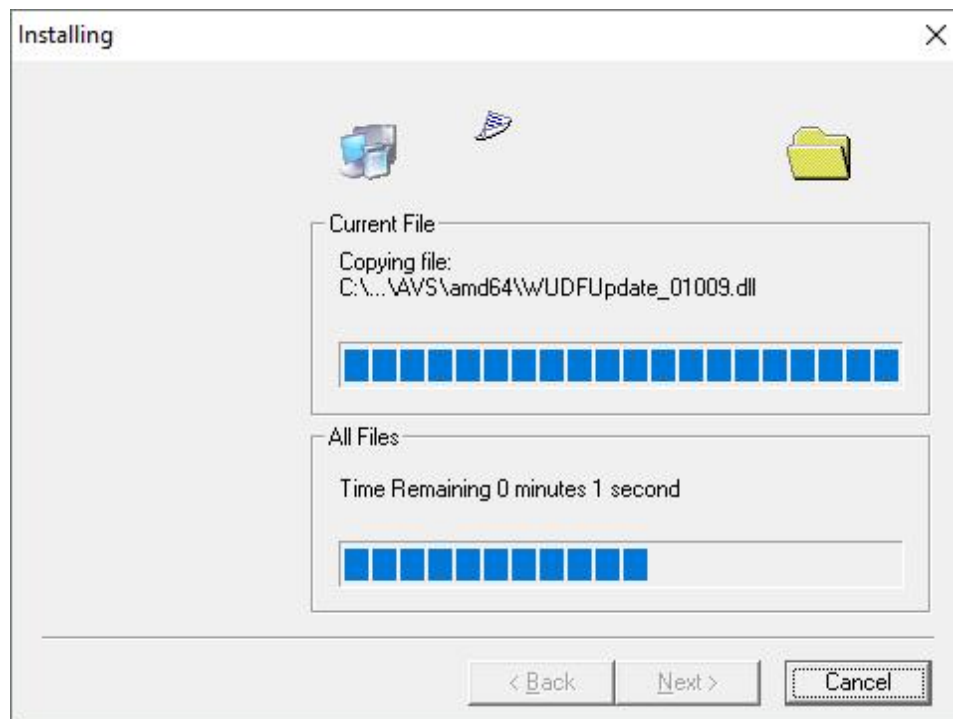

Figure 3-11. USB/Device Driver Installation Progress

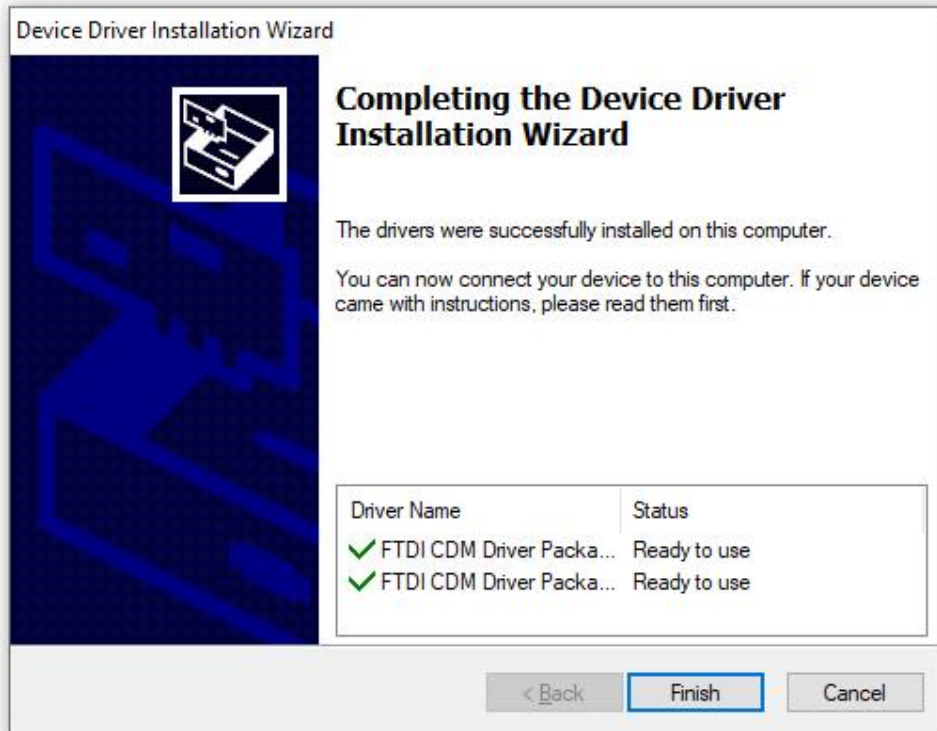

Figure 3-12. USB/Device Driver Installation Completion

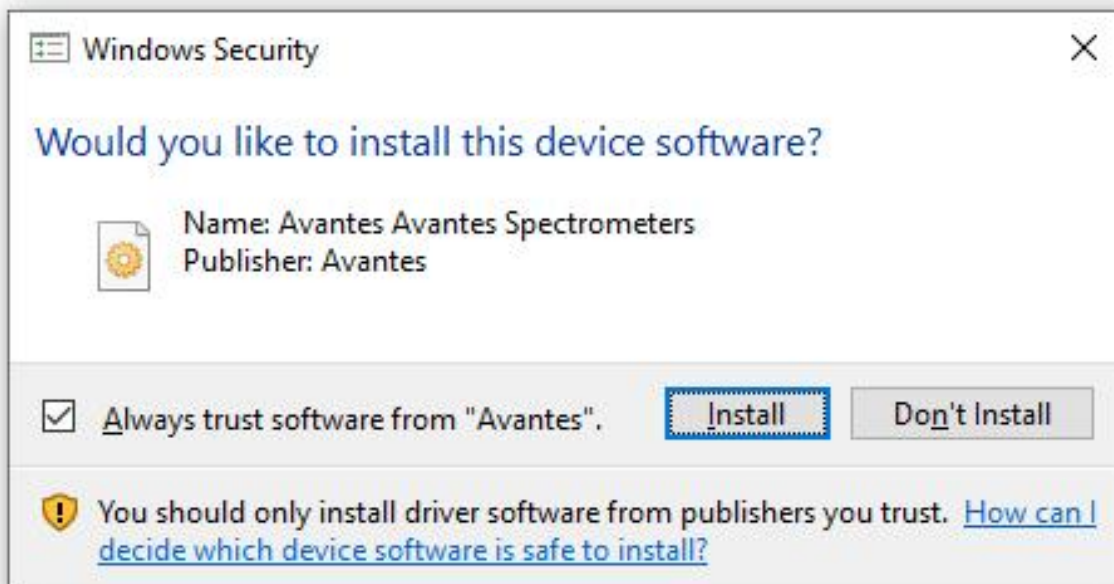

Figure 3-13. Windows Security Prompt to Install Device Software

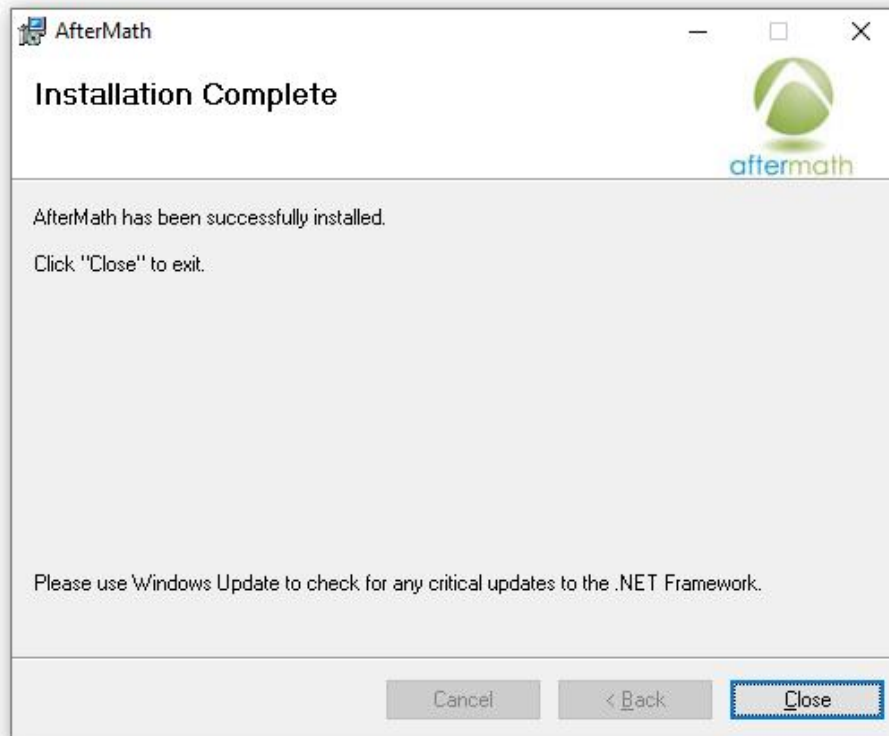

Figure 3-14. Confirmation of Successful AfterMath Installation

3.2.2 Permissions File Verification

On the installation media, there are license files, or "permissions files", which authorize a computer running AfterMath to control specific instruments (see Figure 3-15). If Aftermath is installed on the computer using the installation media shipped with a particular instrument, then these permissions files are automatically copied to the computer.

If AfterMath is downloaded directly from the internet and installed on a computer, then the permissions files may not be present on the computer. Users typically notice this condition when the AfterMath "Perform" button is disabled (gray shading – see Figure 3-16). To be sure the proper permissions files are on the computer, launch the AfterMath software. Separately, view the content on the installation media and locate the permissions files (ending in *.papx file extension). Next, drag and drop the permissions files from the installation media directly into the upper left section of the AfterMath window (see Figure 3-17). The AfterMath program will remember the permissions files even after the program is closed (*i.e.*, this step only needs to be performed once). You may be prompted to accept changes by the AfterMath program.



NOTE:

Contact Technical Service for assistance (see Section 1.6) if you encounter any issues with software licensing or permissions files.

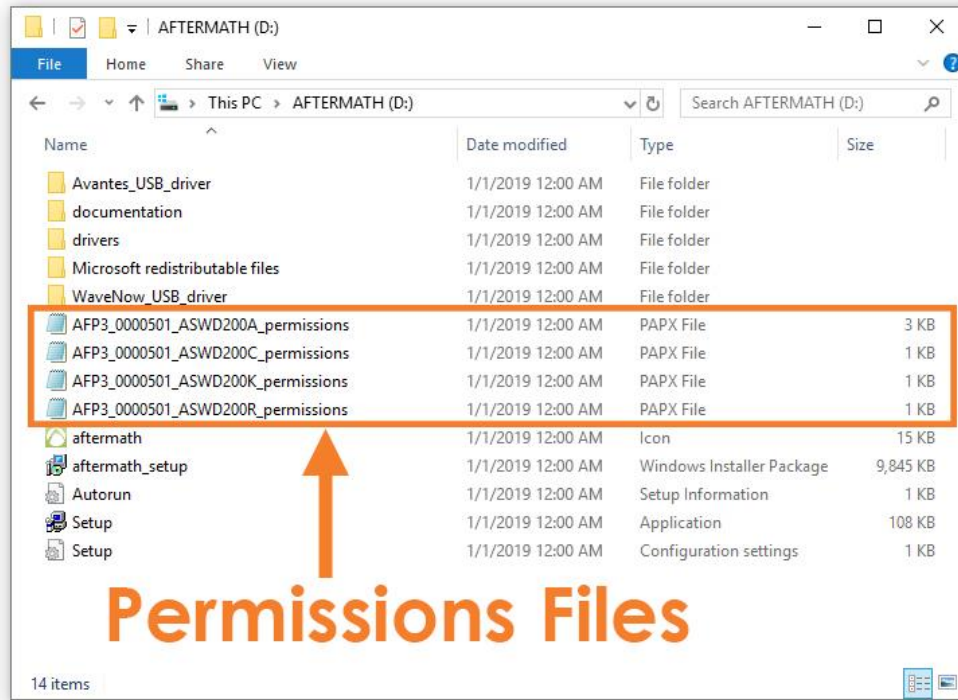
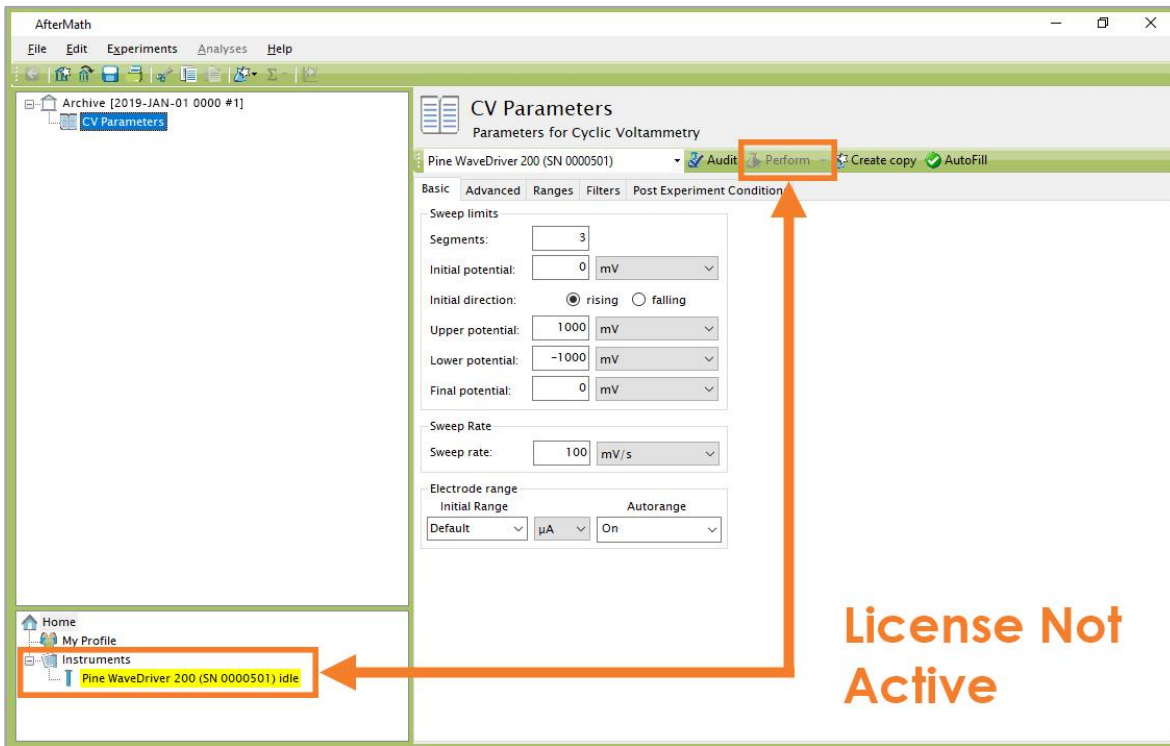

Figure 3-15. Permissions Files on Installation Media



License Not Active

Figure 3-16. Indications that the AfterMath License is not Active

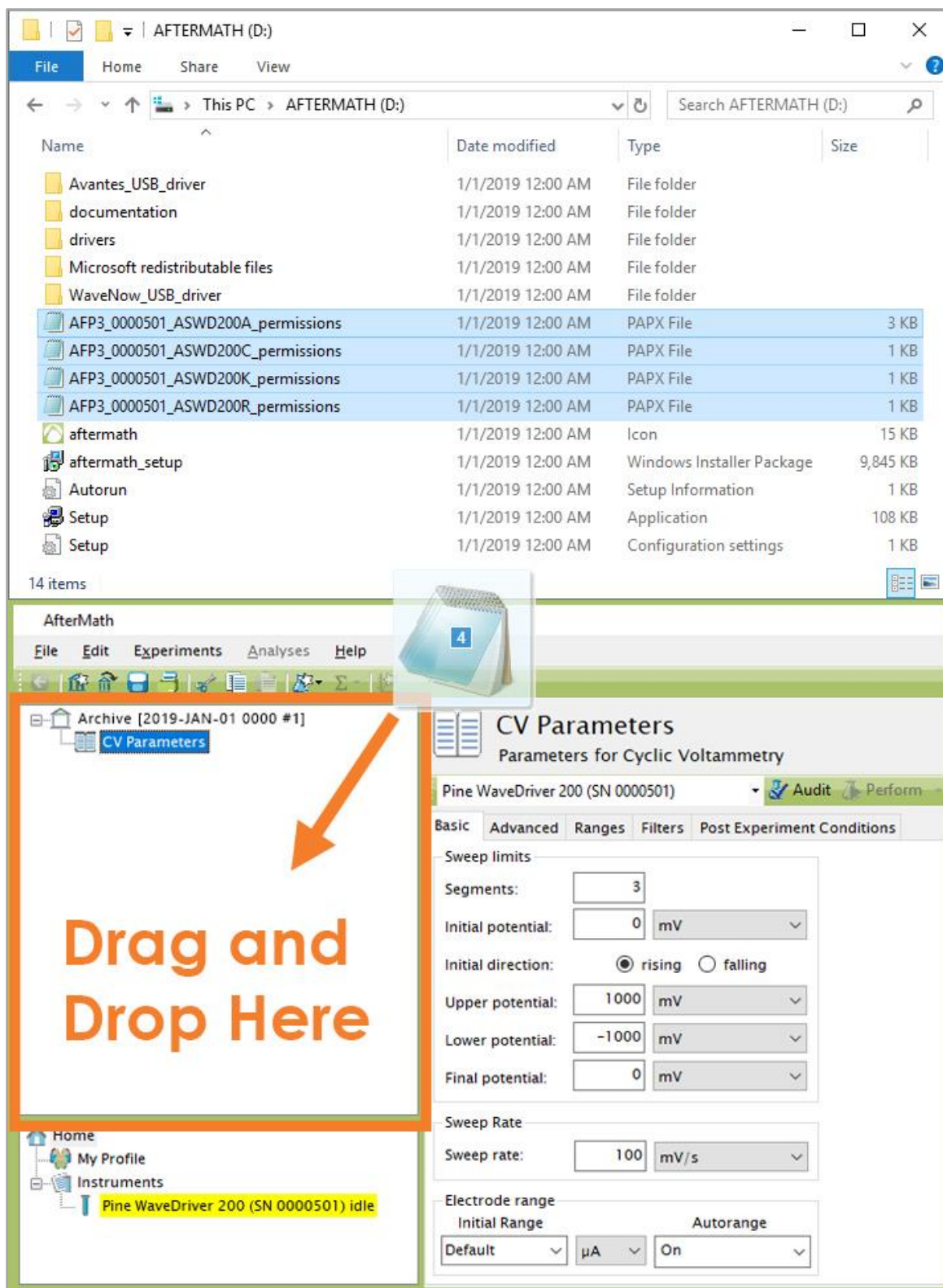

Figure 3-17. Copying Permissions Files to AfterMath

3.3 USB Cable Connection

The WaveDriver 200 connects to a computer using the USB cable supplied with the instrument (Type A male to Type B female USB cable – see Figure 3-18). The USB port on the computer must be capable of USB 2.0 (or better) data transfer rates.



Figure 3-18. USB Cable Connection Between Potentiostat and Computer

3.4 Installation Checklist

The next section of this guide will describe testing and calibrating a fully-installed WaveDriver 200. Before proceeding, ensure the following installation steps have been completed:

- ✓ The WaveDriver 200 instrument is located in a secure, dry location with adequate space
- ✓ Electrical power is connected to the WaveDriver 200
- ✓ AfterMath software is installed on the computer
- ✓ The WaveDriver 200 instrument is connected to a computer via the USB cable

4. System Testing

This section describes how to test the WaveDriver 200 system and calibrate the cell cable for AC experiments (EIS). By connecting the bipotentiostat to a well-behaved network of resistors, capacitors, and/or inductors (using the Pine Research Universal Dummy Cell), the bipotentiostat circuitry can be tested to assure that it is working properly.



TIP:

To verify the instrument is operating correctly, perform the system tests described here. When contacting Technical Service (see Section 1.6) for assistance, the tests described below are often the first suggested actions.

4.1 Test Setup

4.1.1 Launch the AfterMath Software

Launch AfterMath, which should already be installed on the computer (see Section 3), and log into AfterMath (see Figure 4-1). Click "OK" on the AfterMath Login dialog window to start the program.

Click the
AfterMath
icon to
launch the
application

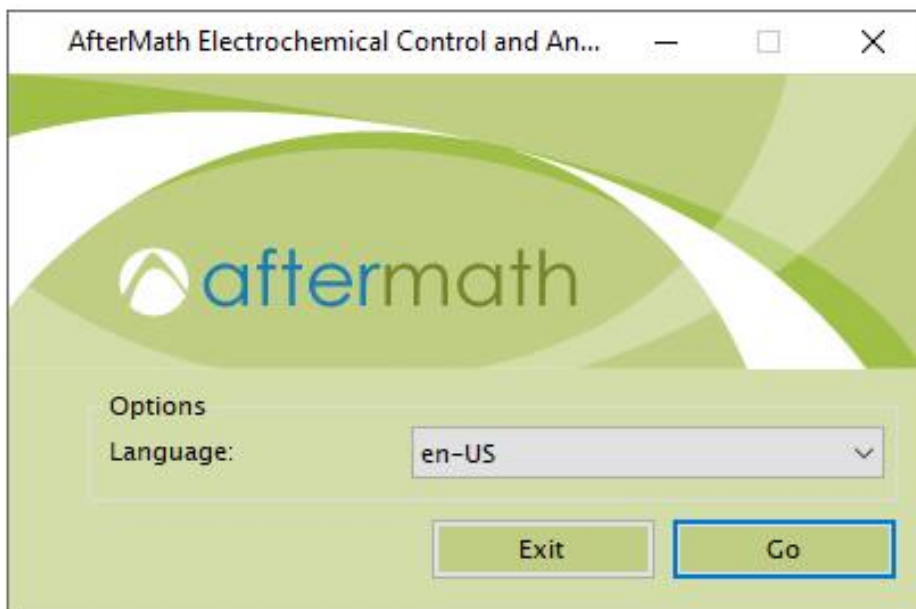

Figure 4-1. Initial Login Screen when Starting AfterMath

4.1.2 Verify Instrument Status

Turn on the instrument using the front panel power switch and wait for the WaveDriver 200 to appear in the AfterMath instruments list. The instrument should appear along with its serial number under the "Instruments" node (see lower-left portion of the screenshot shown in Figure 4-2).

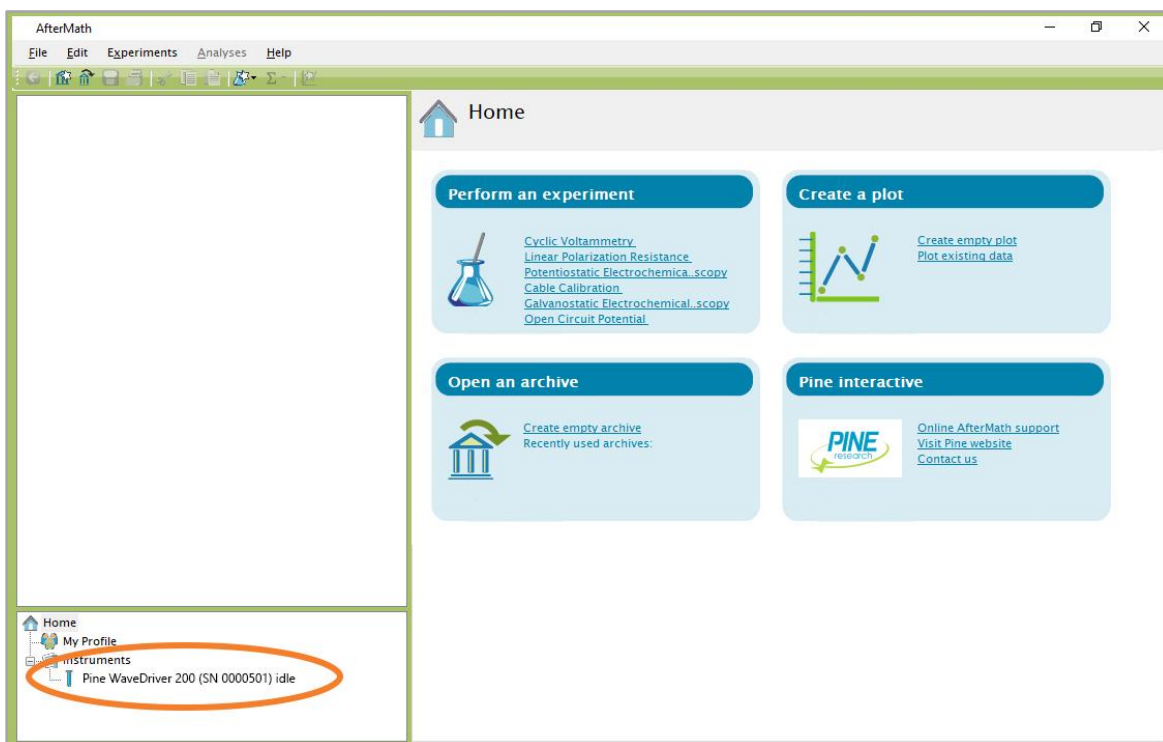

Figure 4-2. AfterMath Screenshot with Connected Instrument Circled

4.1.3 Confirm Connections

Check the status LED on the front panel of the WaveDriver 200. After about fifteen seconds, this LED should be green, indicating that the instrument is idle (see Figure 4-3). Also, the USB indicator light should flicker occasionally (see Table 2-4 for more information about LED indicators).



Figure 4-3. Indicator Lights on the Front Panel of the WaveDriver 200

4.1.4 Review Instrument Status

Examine the instrument status display (see Figure 4-4). The information on the "Idle" tab may initially indicate that the cell is disconnected. If desired, the controls on this tab can be used to apply a known idle condition to the cell. In the example shown below (see Figure 4-4), the instrument is connected to the external cell, and both working electrodes are set to idle under potentiostatic control while applying 1.2 V to the first working electrode (K1) and 0.0 V to the second working electrode (K2).

Control External Cell Idle Conditions Here

Monitor Actual Conditions Here

The screenshot shows the AfterMath software interface. The main window is titled "Instrument status" and has tabs for "Idle", "Queue", "Device", and "Connection". The "Idle" tab is active. Under "Control", the "Cell connection" is set to "Connected - external". For "Electrode mode (K1)", "Potentiostat" is selected with a potential of 1.2 V. For "Electrode mode (K2)", "Potentiostat" is selected with a potential of 0 V. The "Status" section shows "Cell Connection: External". For "Electrode - K1", the mode is "Potentiostat" with a potential of 1.192 V and a current of -157.9 μ A. For "Electrode - K2", the mode is "Potentiostat" with a potential of 0.009100 V and a current of -358.0 μ A.

Figure 4-4. AfterMath Instrument Status Window showing External Cell Idle Conditions

4.2 Single Channel (K1) DC Test

4.2.1 Connect to the Pine Research Universal Dummy Cell



NOTE:

If using the legacy EIS Calibration & Dummy Cell (Pine Research part number AFDUM5) that was included with a WaveDriver 200 purchased before November 2020, refer to corresponding instructions in Section 10.2.

Securely connect the cell cable to the front panel of the WaveDriver 200. Remove the alligator clip from the RED lead and plug it into the back of the ORANGE lead so the leads are stacked together. Do the same with the GREEN lead into the WHITE lead, and the BLUE lead into the PURPLE lead. Using an alligator clip, connect the RED+ORANGE stacked leads to the metal post labeled “WK1+WK1S” on “Cell C” of the Pine Research Universal Dummy Cell. Next, connect the GREEN+WHITE leads to the metal post labeled “CTR+REF”, and connect the BLUE+PURPLE leads to the metal post labeled “WK2+WK2S” (see Figure 4-5, left). Place the connected dummy cell into the bottom half of the dummy cell metal case.

Connect the GRAY lead (instrument chassis) to the banana jack on the side of the metal case. Connecting the two chassis terminals together effectively shields the instrument circuitry and the components of the dummy cell within the same overall Faraday cage (see Section 6 to learn more about grounding). Slide the top half of the metal case into place (see Figure 4-5, right).

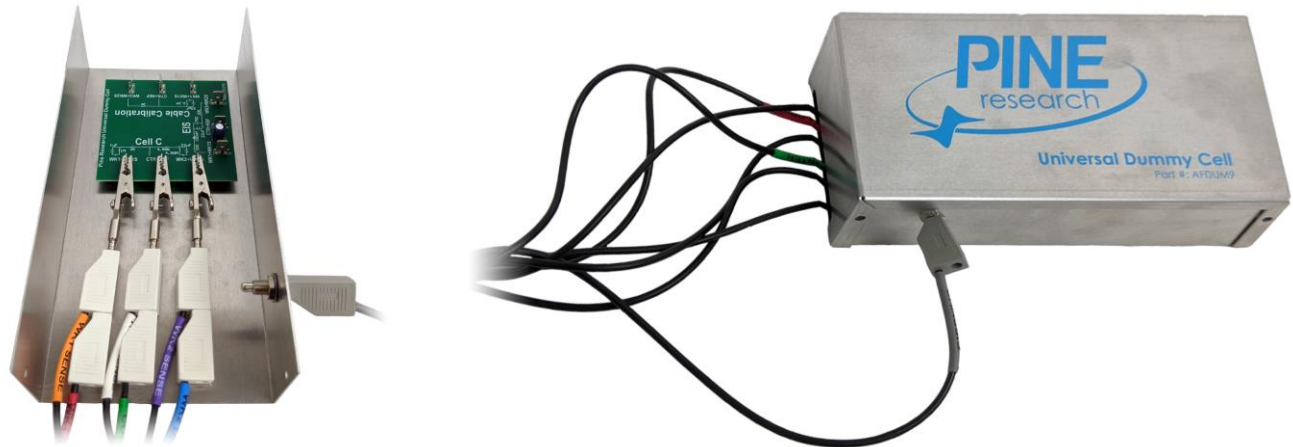
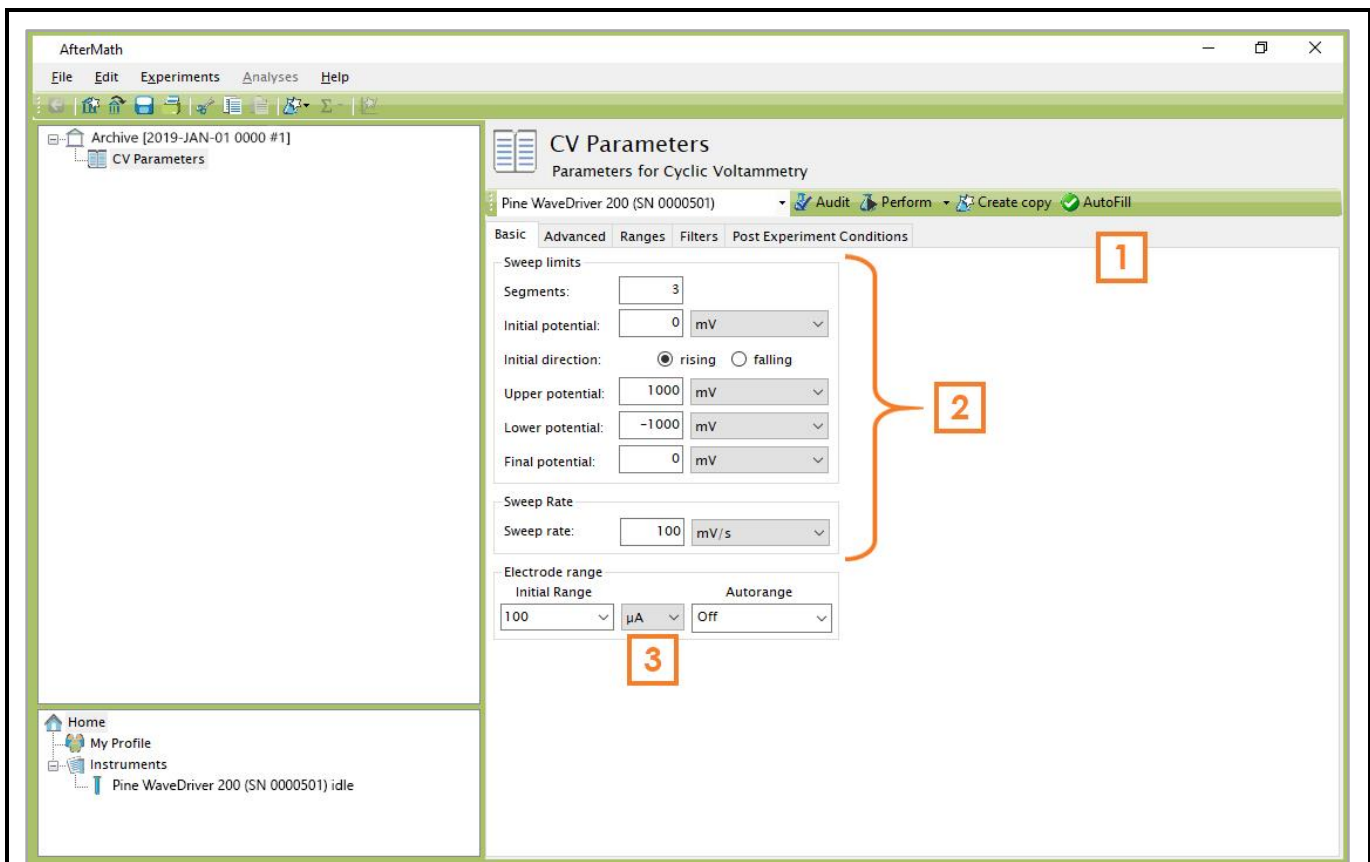

Figure 4-5. WaveDriver 200 Cell Cable Connected to “Cell C” of Dummy Cell



1	Click on the “AutoFill” button. Note that default parameters appear automatically (including the Number of Segments, the Sweep Limits, and the Sweep Rate).
2	These parameters control the waveform used during the experiment.
3	Set the Electrode Range to “100 μ A” and set Autorange “Off” (this disables auto-ranging and selects the 100 μ A range for use throughout the test).

Figure 4-6. Cyclic Voltammetry (CV) Parameters Dialog Window

4.2.2 Create a Cyclic Voltammetry (CV) Experiment

From the AfterMath Experiments menu, choose Cyclic Voltammetry (CV). Doing so creates a “CV Parameters” node within a new archive. Configure the parameters as shown (see Figure 4-6).

4.2.3 Audit Experimental Parameters

Choose the WaveDriver 200 bipotentiostat in the drop-down menu (see Figure 4-7, to the left of the “Audit” button), and then press the “Audit” button to check the parameters. AfterMath will perform a quick audit of the parameters to ensure that all parameters are specified and within allowed ranges.

4.2.4 Initiate the Experiment

Click the “Perform” button to initiate the CV experiment. The “Perform” button is located just to the right of the “Audit” button (see Figure 4-7).

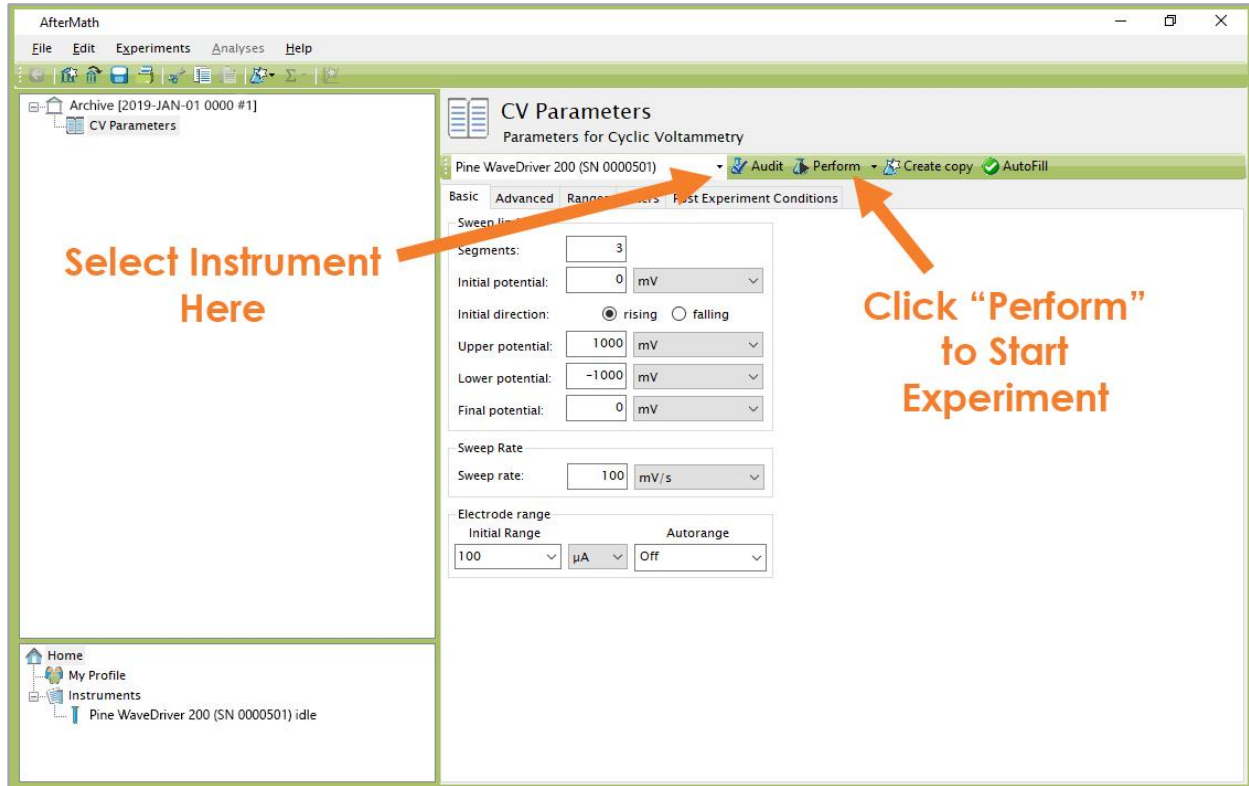

Figure 4-7. Location of Instrument Selection Menu and Perform Button



NOTE:

If the “Perform” button is disabled (shaded gray), this is an indication that the AfterMath software on the computer is not licensed to control the instrument. The remedy for this issue is to obtain and install the appropriate permissions files (see Section 3.2.2).

4.2.5 Monitor Experimental Progress

Monitor the progress of the experiment by observing the real time plot, the percentage complete value, and the progress bar (see Figure 4-8).

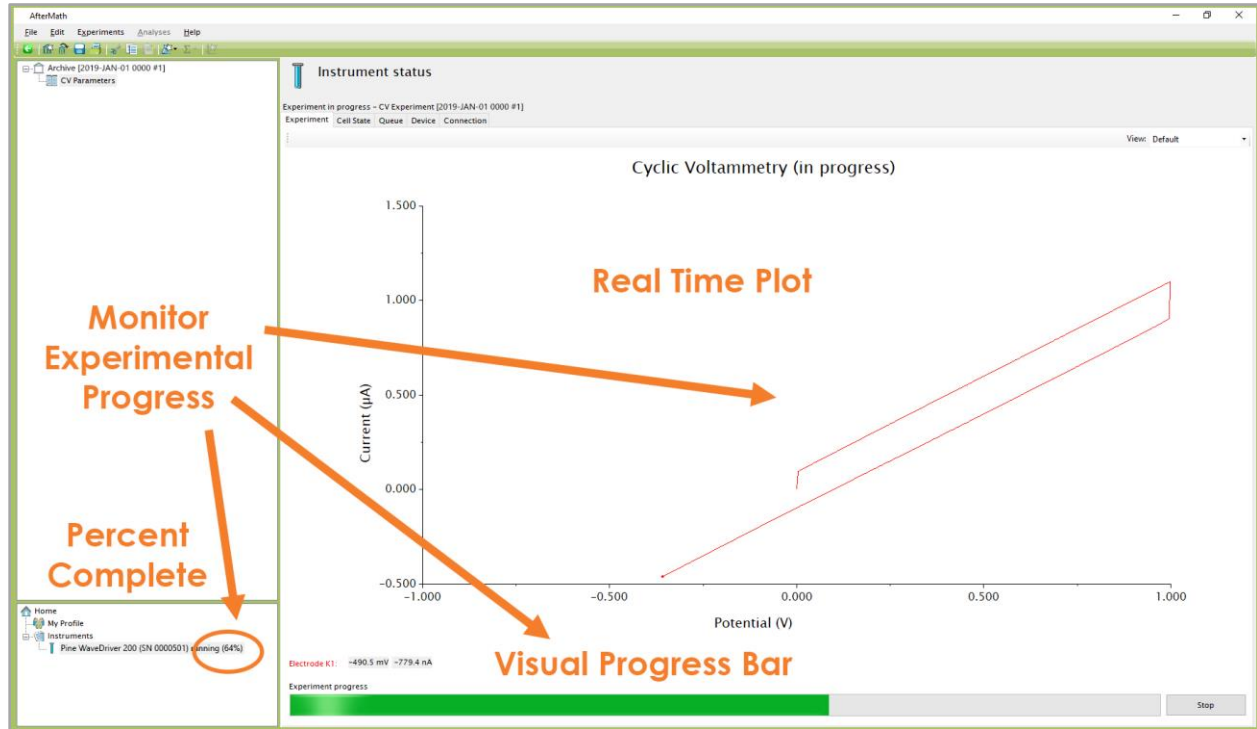



Figure 4-8. Monitoring the Progress of the CV Experiment

4.2.6 Review the Results

When the experiment is complete, the results of the experiment are placed in a folder within the archive (see Figure 4-9). In addition to the main voltammogram plot, additional graphs are available in the “Other Plots” folder. The results can also be viewed in tabular form under the “experiment” node.



EXPECTED RESULT:

The anticipated test result (see Figure 4-9) is a diagonally-slanted parallelogram. The slope of this parallelogram (~998 nS) is the reciprocal of the dummy cell resistance (~1.002 MΩ). The vertical height at any given position along the parallelogram is related to the dummy cell capacitance (see Section 4.2.7 for more details).

4.2.7 Understanding the Results

The total resistive load sensed by the first working electrode (K1) is a series combination of two resistors with values 1.0 MΩ and 2.0 kΩ (see Figure 2-4 for the schematic of the Pine Research Universal Dummy Cell). The voltammogram is a plot of current vs. potential governed by Ohm's Law as follows,

$$E = iR \quad (\text{Ohm's Law}) \quad (1)$$

where E is the potential, i is the current, and R is the resistive load. Considering that the cyclic

voltammogram (see Figure 4-9) plots current along the vertical axis and potential along the horizontal axis, the slope (i/E) is equal to the reciprocal of the resistive load ($1/R = 1 / 1.002 \text{ M}\Omega = 998 \text{ nS}$).

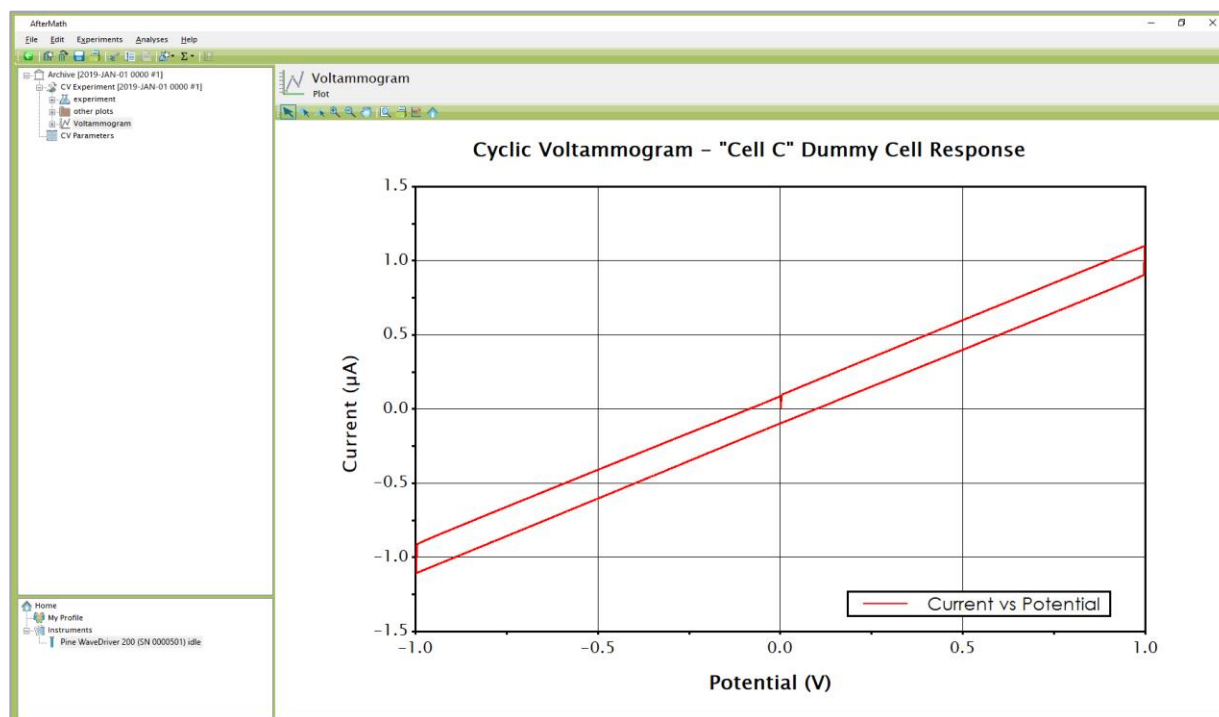

Figure 4-9. Anticipated CV Results (using “Cell C” of Dummy Cell)

To measure the actual slope, right-click on the cyclic voltammogram trace, and then select the “Baseline” option from the “Add Tool” sub-menu. A baseline measurement tool appears on the voltammogram (see Figure 4-10), and by adjusting the tool control points, the slope along any portion of the voltammogram can be measured. The slope along the diagonal part of the voltammogram should be $\sim 998 \text{ nS}$.

The capacitive load presented to the working electrode is $\sim 1.0 \mu\text{F}$ (see Figure 2-4 for the schematic of the Pine Research Universal Dummy Cell). The vertical separation observed between the forward and reverse segments at any point along the voltammogram is related to this capacitance. This capacitance is meant to mimic the double-layer capacitance, C_{DL} , observed at the surface of an actual electrode.

Whenever a potential sweep is applied across a capacitive load, a charging current is observed. In the context of the electrode double-layer concept, the double-layer charging current (i_{DL}) is related to the potential sweep rate (v) and the double-layer capacitance (C_{DL}) by the following equation:

$$i_{DL} = C_{DL}v \quad (2)$$

A cyclic voltammogram across a capacitor consists of a forward (*i.e.*, charging) segment and a reverse (*i.e.*, discharging) segment. The vertical separation between the two segments at any point along the voltammogram is two times the capacitive charging current.

To measure this vertical separation in AfterMath, right-click on the voltammogram trace and select the “Crosshair” option from the “Add Tool” sub-menu. Drag the crosshair cursor to any point on the upper segment of the voltammogram and make note of the current and potential at that point (see Figure 4-10). Next, create a second crosshair tool and drag it to the lower segment of the voltammogram. Position the second crosshair at the same (or nearly the same) potential as the first crosshair tool and make a note of the current and potential at that point.

Half the difference between the currents measured at the two crosshair points is the charging current. For the example shown here (see Figure 4-10), half the difference in current between the two points is calculated as $0.0988 \mu\text{A}$. With knowledge of the potential sweep rate (100 mV/s), the capacitive load can be calculated as $0.988 \mu\text{F}$, which is in good agreement with the nominal capacitance shown in the dummy cell circuit schematic (see Figure 2-4).

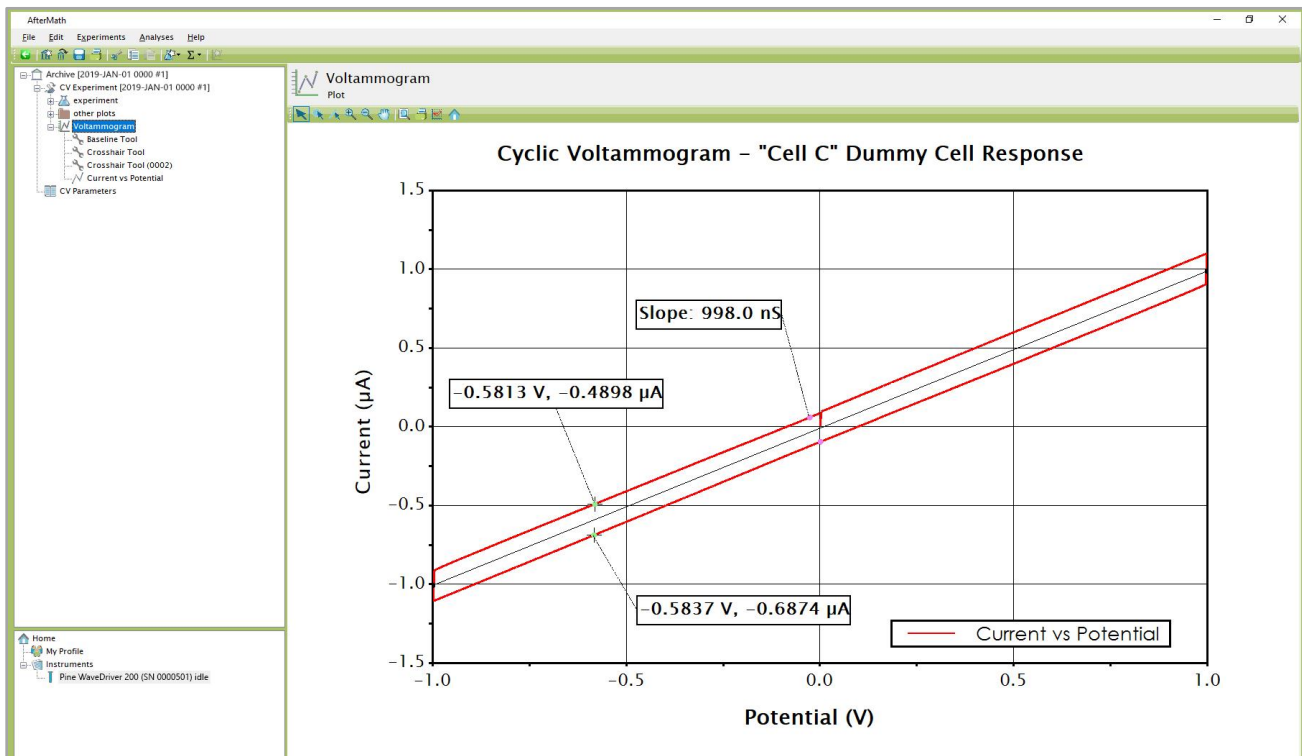

Figure 4-10. Analyzed CV Results (using “Cell C” of Dummy Cell)



EXPLORE ADDITIONAL EXPERIMENTAL RESULTS:

Archive nodes often have a “+” sign next to the node name. Click on this “+” sign to open the node. In addition to the main plot produced by an experiment, additional results can be found in the “Experiment” node and in the “Other Plots” node. Nodes may be renamed and organized in folders as desired.

4.3 Dual Channel (K1 and K2) DC Test

4.3.1 Connect to the Pine Research Universal Dummy Cell



NOTE:

If using the legacy EIS Calibration & Dummy Cell (Pine Research part number AFDUM5) that was included with a WaveDriver 200 purchased before November 2020, refer to corresponding instructions in Section 10.2.

Connect the WaveDriver 200 cell cable leads to “Cell C” of the Pine Research Universal Dummy Cell in identical fashion to the previous Single Channel DC Test (see Section 4.2.1 for connection instructions; see Figure 4-5 for illustration).

4.3.2 Create a Dual Electrode Cyclic Voltammetry (DECV) Experiment

Choose the Dual Electrode Cyclic Voltammetry (DECV) option from the Dual electrode methods sub-menu in the AfterMath Experiments menu. A new DECV specification will be created and placed into a new archive. Configure the parameters as detailed below (see Figure 4-11).

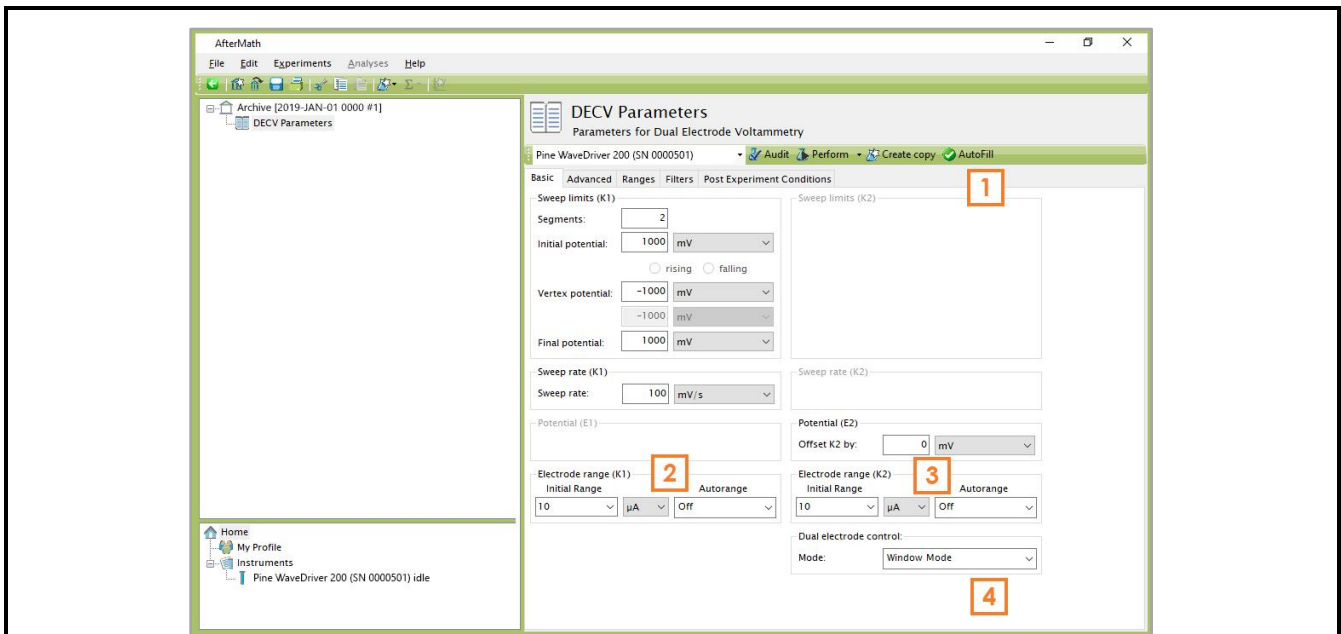

1	Click on the “AutoFill” button. Note that default parameters for number of Segments, Sweep limits, and Sweep rate appear automatically.
2	Set the Electrode range (K1) to “10 µA” with Autorange “Off”
3	Set the Electrode range (K2) to “10 µA” with Autorange “Off”
4	Change the Dual electrode control mode to “Window Mode”

Figure 4-11. Dual Electrode Cyclic Voltammetry (DECV) Parameters Dialog Window

4.3.3 Modify the Potential Range Setting

Select the 2.5 V range for both working electrodes (K1 and K2) via the following steps:

1. Click the “Ranges” tab (see Figure 4-12).
2. Change the potential electrode range for both K1 and K2 to 2.5 V and set Autorange to “Off”.

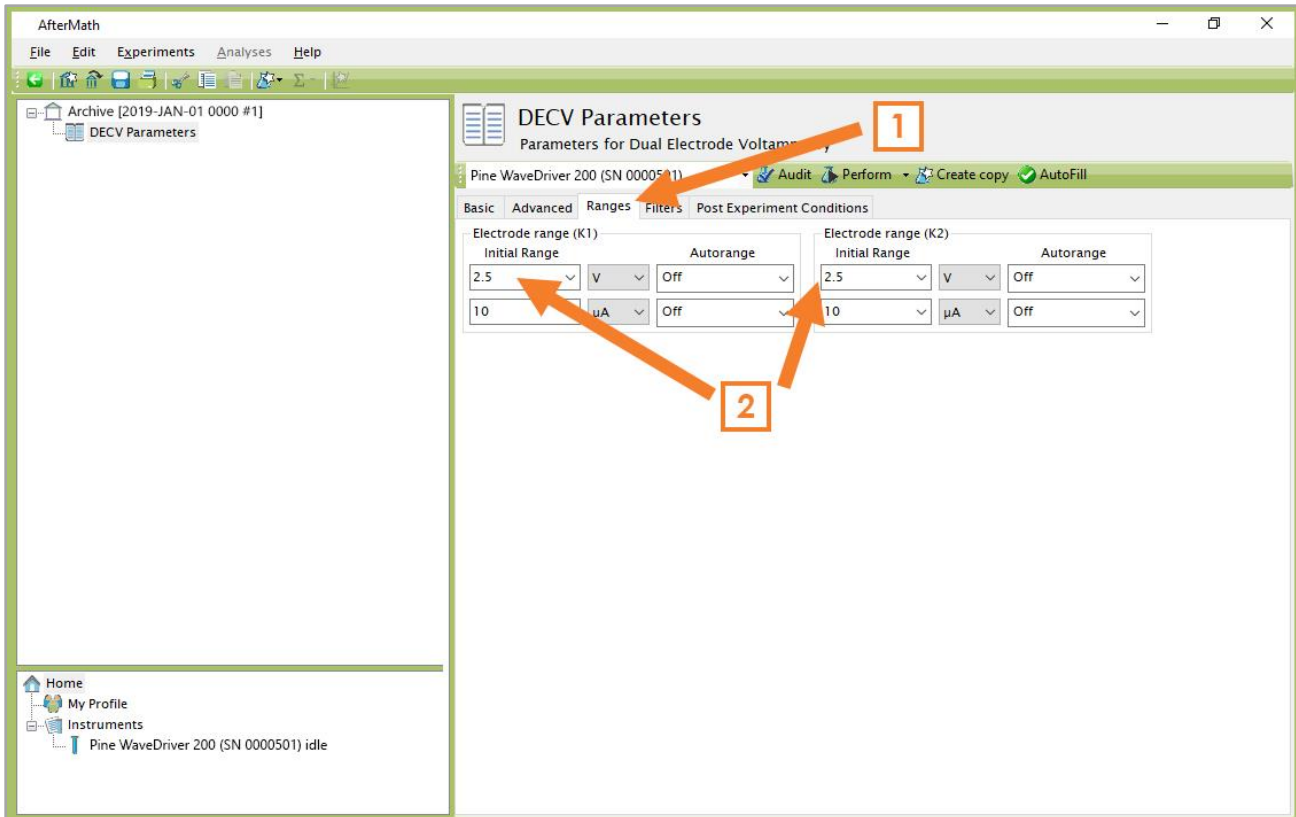

Figure 4-12. Adjusting the Potential Ranges on the “Ranges” Tab (DECV)

4.3.4 Audit Experimental Parameters

Choose the WaveDriver 200 in the drop-down menu (see Figure 4-13, to the left of the “Audit” button). Press the “Audit” button to check the parameters. AfterMath will perform a quick audit of the parameter values to ensure that all required parameters have been specified and are within allowed ranges.

4.3.5 Initiate the Experiment

Click on the “Perform” button to initiate the DECV experiment. The “Perform” button is located to the right of the “Audit” button (see Figure 4-13).

4.3.6 Monitor Experimental Progress

Monitor the progress of the DECV experiment in AfterMath by observing the real time plot, the percentage complete value, and the progress bar (see Figure 4-14).

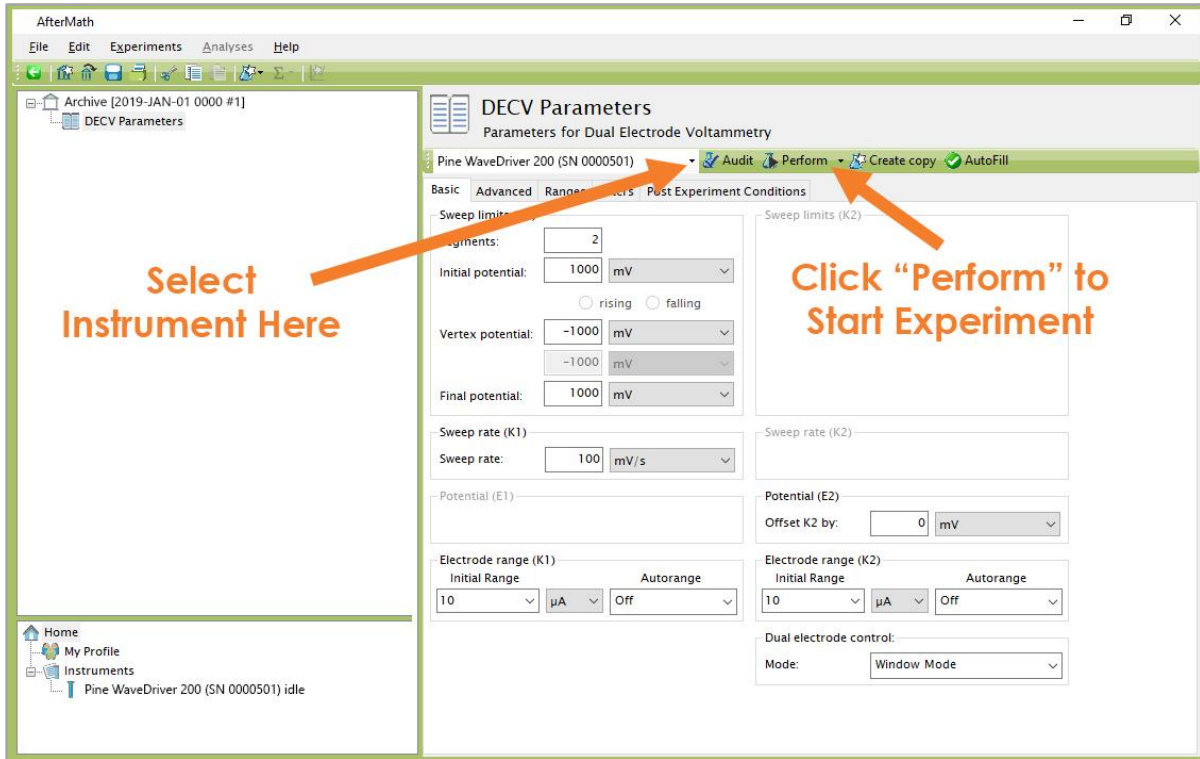

Figure 4-13. Location of Instrument Selection Menu and Perform Button (DECV)

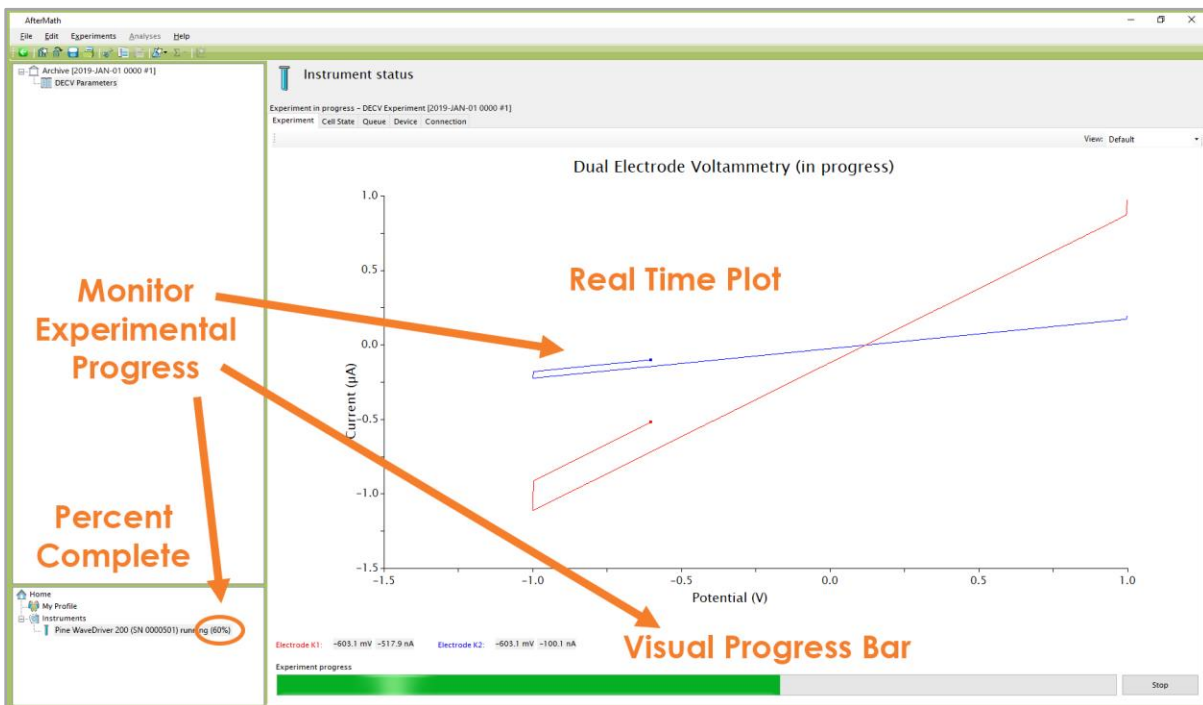

Figure 4-14. Monitoring the Progress of the DECV Experiment (K1 and K2)

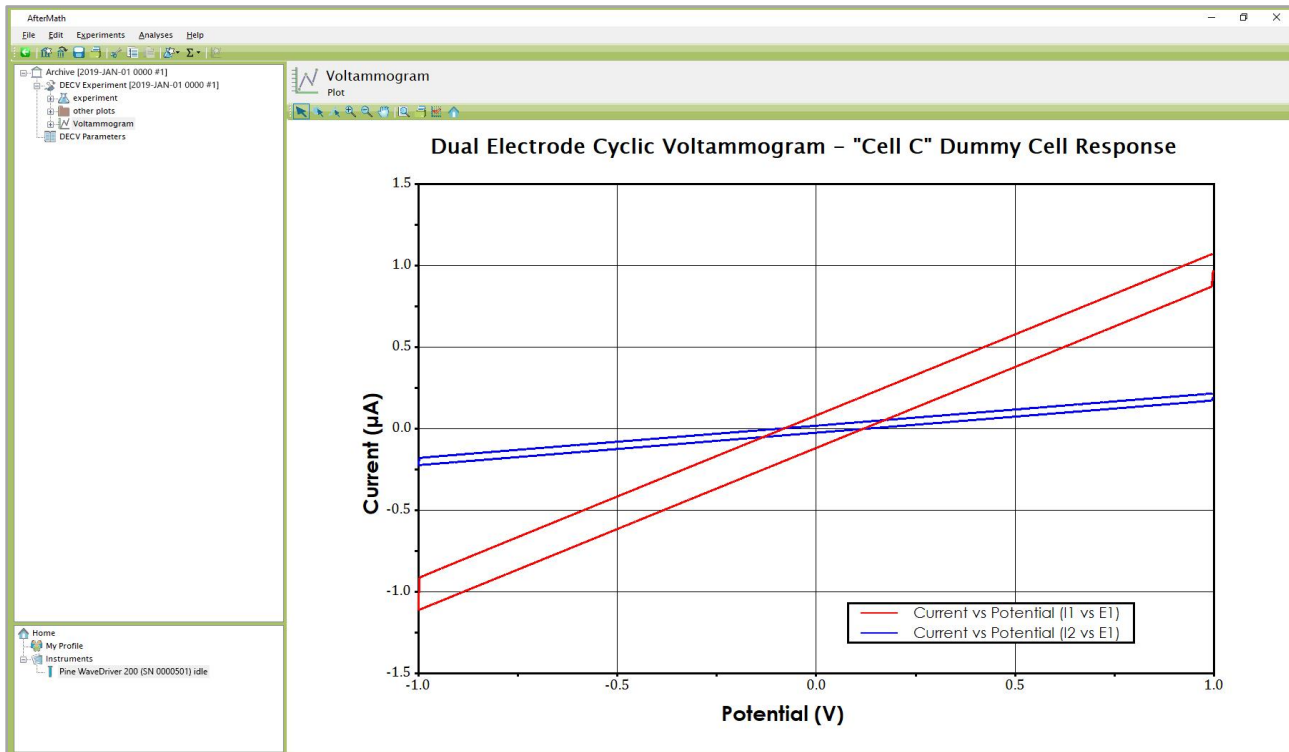

Figure 4-15. Anticipated DECV Results (using “Cell C” of Dummy Cell)

4.3.7 Review the Results

When the experiment has finished, the results of the experiment are placed in a folder within the archive (see Figure 4-15). In addition to the voltammogram, additional graphs are available in the “Other Plots” folder. The results can also be viewed in tabular form under the “Experiment” node.

EXPECTED RESULT:



The anticipated test results are two diagonally-slanted parallelograms with different slopes (see Figure 4-15). The slope of the red trace is inversely proportional to the resistance sensed by first working electrode ($\sim 1.002 \text{ M}\Omega$), and the slope of the blue trace is inversely proportional to the resistance sensed by the second working electrode ($\sim 5.005 \text{ M}\Omega$). The vertical separation between sweep segments is related to the capacitance sensed by the both working electrodes (see Section 4.3.8).

4.3.8 Understanding the Results

Analysis of the DECV results is similar to the single channel CV test (see Section 4.2.7), except there are two voltammograms instead of one (see Figure 4-15). The red voltammogram corresponds to the first working electrode (K1) and the blue voltammogram corresponds to the second working electrode (K2). The overall resistive loads presented to the working electrodes by the dummy cell (see Figure 2-4) are $1 \text{ M}\Omega + 2 \text{ k}\Omega = 1.002 \text{ M}\Omega$ (for K1) and $4.99 \text{ M}\Omega + 4.99 \text{ k}\Omega = 4.995 \text{ M}\Omega$ (for K2).

AfterMath software baseline tools may be used to measure the slopes of the two voltammograms (see Section 4.2.7 for baseline tool instructions), and Ohm's law (Equation 1) may be used to relate the measured slopes to the resistive load sensed by each electrode. For the example shown here (see Figure 4-16), the slope for the first voltammogram (K1) is calculated as 994.2 nS, and the slope for the second voltammogram (K2) is calculated as 198.2 nS. The reciprocals of these two slopes (1.006 M Ω for K1 and 5.045 M Ω for K2) are in good agreement with the resistive loads found on the dummy cell schematic (see Figure 2-4).

The nominal capacitive loads presented to the working electrodes by the dummy cell (see Figure 2-4) are 1 μ F (for K1) and 0.22 μ F (for K2). Using the AfterMath software crosshair tools (in a manner similar to that described in Section 4.2.7) with the example voltammograms shown here (see Figure 4-16), the measured values (1.009 μ F and 223.6 nF) are in good agreement with the nominal capacitance values.

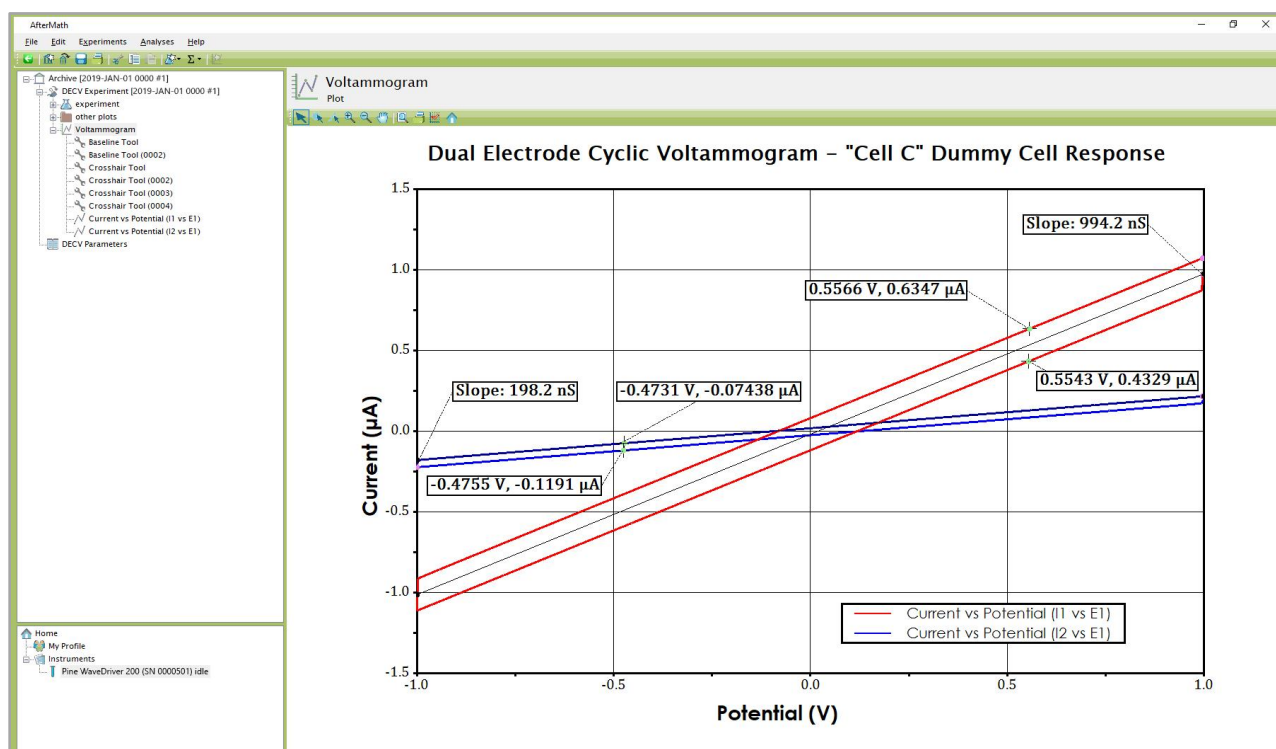

Figure 4-16. Analyzed DECV Results (using "Cell C" of Dummy Cell)

4.4 Cell Cable Calibration

The electrical properties of the cell cable (resistance, capacitance, and inductance) can potentially interfere with electrochemical measurements. The effect of these cable properties on experimental data from DC electrochemical techniques is typically negligible; however, for AC techniques (such as EIS) the impact of the cell cable must be taken into account. Failure to properly calibrate and compensate for cell cable properties can lead to erroneous results, especially when making EIS measurements at high frequency.

4.4.1 Connect to the Pine Research Universal Dummy Cell



NOTE:

If using the legacy EIS Calibration & Dummy Cell (Pine Research part number AFDUM5) that was included with a WaveDriver 200 purchased before November 2020, refer to corresponding instructions in Section 10.3.

Connect the WaveDriver 200 cell cable leads to the Pine Research Universal Dummy Cell in identical fashion to the previous Single Channel DC Test (see Section 4.2.1 for connection instructions), except the leads should be connected to the side labeled “Cable Calibration” (see Figure 4-17 for illustration).

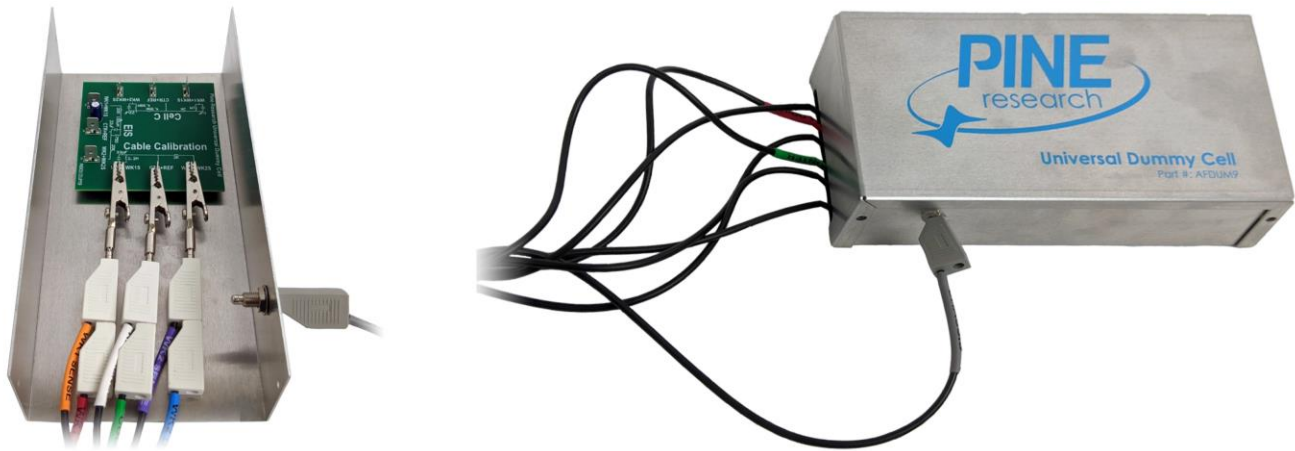

Figure 4-17. WaveDriver 200 Cell Cable Connected to “Cable Calibration” on Dummy Cell

4.4.2 Create a Cable Calibration (EIS-CCAL) Experiment

Choose the Cable Calibration (EIS-CCAL) option from the Impedance Spectroscopy sub-menu in the AfterMath Experiments menu. A new EIS-CCAL specification will be created and placed into a new archive. Unlike other experiments in AfterMath, EIS-CCAL does not require the user to fill in any parameters. Still, there are grayed-out experimental parameters shown that confirm certain details related to the calibration experiment, including the Load Capacitance used during calibration and the Target Frequency at which cable capacitance is calculated (see Figure 4-18).

4.4.3 Initiate the Experiment

Click on the “Perform” button to initiate the EIS-CCAL experiment. The “Perform” button is located to the right of the “Audit” button, which in this case is grayed-out and inaccessible (see Figure 4-18).

4.4.4 Monitor Experimental Progress

Monitor the progress of the EIS-CCAL experiment in AfterMath by observing the real time plot and the progress bar (see Figure 4-19). Procedurally, a short EIS experiment will occur with live data updating automatically. Similarly to an actual EIS test (see Section 4.5), the default live display shows Lissajous

plots, but Bode or Nyquist plots can also be observed in real time if desired (see Section 4.7 for more complete details regarding EIS experiments).

**NOTE:**

During an EIS-CCAL experiment, the percentage complete value displayed at the bottom left portion of the screen refers to each individual frequency and is not indicative of the overall experimental progress.

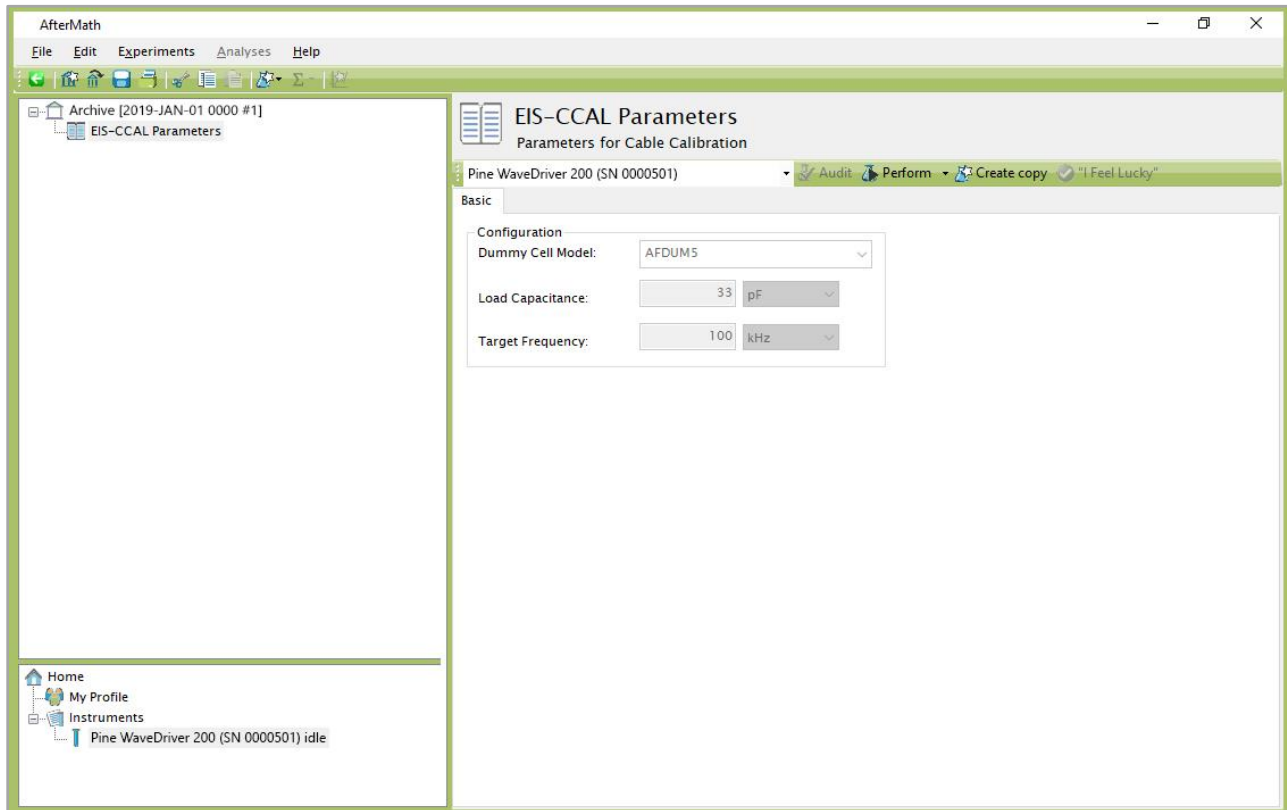

Figure 4-18. Cable Calibration (EIS-CCAL) Experiment Dialog Window

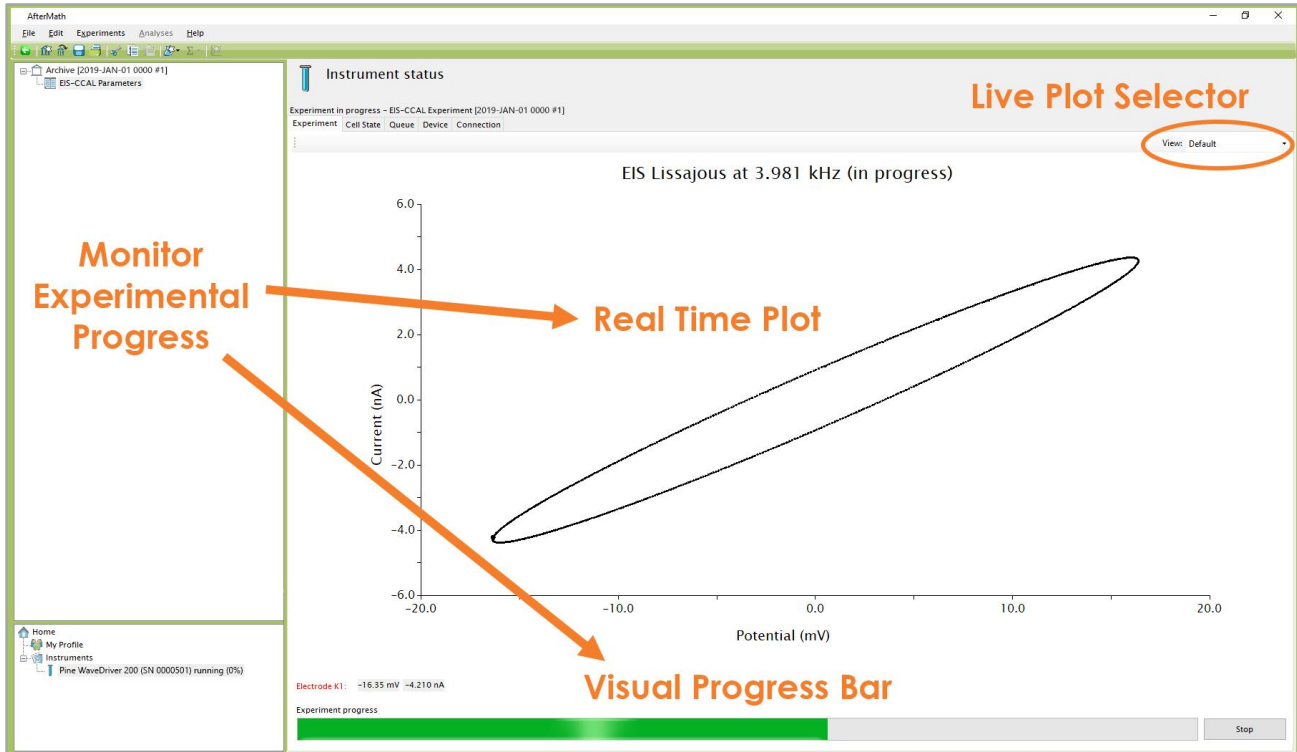

Figure 4-19. Monitoring the Progress of the EIS-CCAL Experiment

4.4.5 Review the Results

After the experiment has finished, AfterMath automatically determines the cable capacitance and stores the capacitance value inside the instrument for use with subsequent EIS experiments. The measurement details are shown as a plot in the experimental results (see Figure 4-20), and the plot title indicates the measured capacitance value. Generally, the cell cable capacitance falls in the range from 50 to 150 pF depending on the particular design and length of the cell cable.

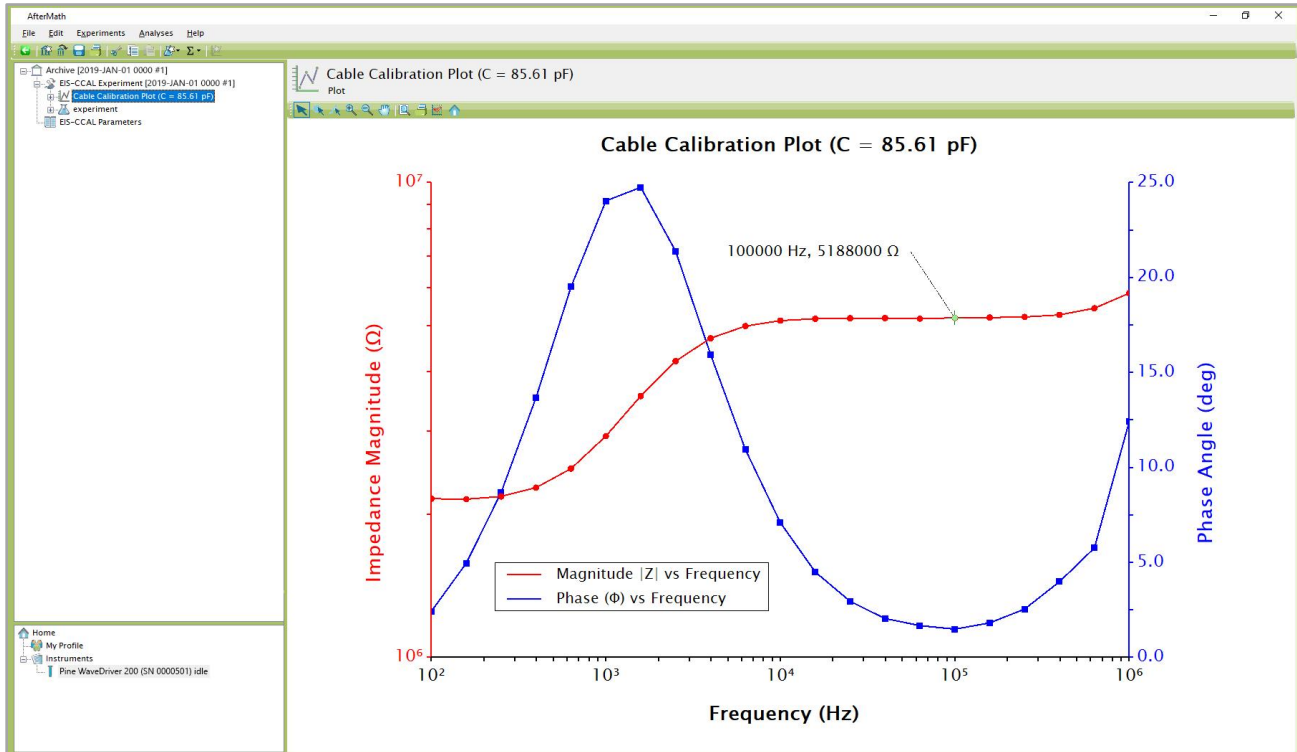

Figure 4-20. Anticipated EIS-CCAL Results (using "Cable Calibration" on Dummy Cell)



NOTE:

WaveDriver 200 cell cable calibration information is stored internally within the instrument and then used for all subsequent EIS measurements. Repeated cell calibration is unnecessary, even if the instrument is connected to a different computer system.



TIP:

If the cell cable is replaced, the cell cable calibration should be performed again on the new cable since no two cables have exactly the same electrical properties. Perform all steps in Sections 4.4, 4.5, and 4.6 to calibrate and characterize the new cell cable.

4.5 Open Lead Test

An “open lead” test explores the absolute upper load measurement limit for EIS measurements across a range of frequencies. Measurements made at these extreme limits fall well outside the 5%, 5° region shown on the Accuracy Contour Plot (see Figure 2-1). The open lead test is simply a quick diagnostic test, and the results of the test should never be interpreted as a measurement of instrument accuracy.

4.5.1 Arrange the Cell Cable

Remove the alligator clips from the cell cable. Configure the cell cable by shorting (stacking) together three pairs of banana plugs as follows:

1. Stack the banana plugs for the RED and ORANGE leads together (K1 drive and sense).
2. Stack the banana plugs for the GREEN and WHITE leads together (counter and reference).
3. Stack the banana plugs for the BLUE and PURPLE leads together (K2 drive and sense).

Place the RED/ORANGE pair inside of a Faraday cage (see Figure 4-21). Verify that the RED/ORANGE pair is not in direct electrical contact with any other conductive object inside the Faraday cage or with the Faraday cage itself.

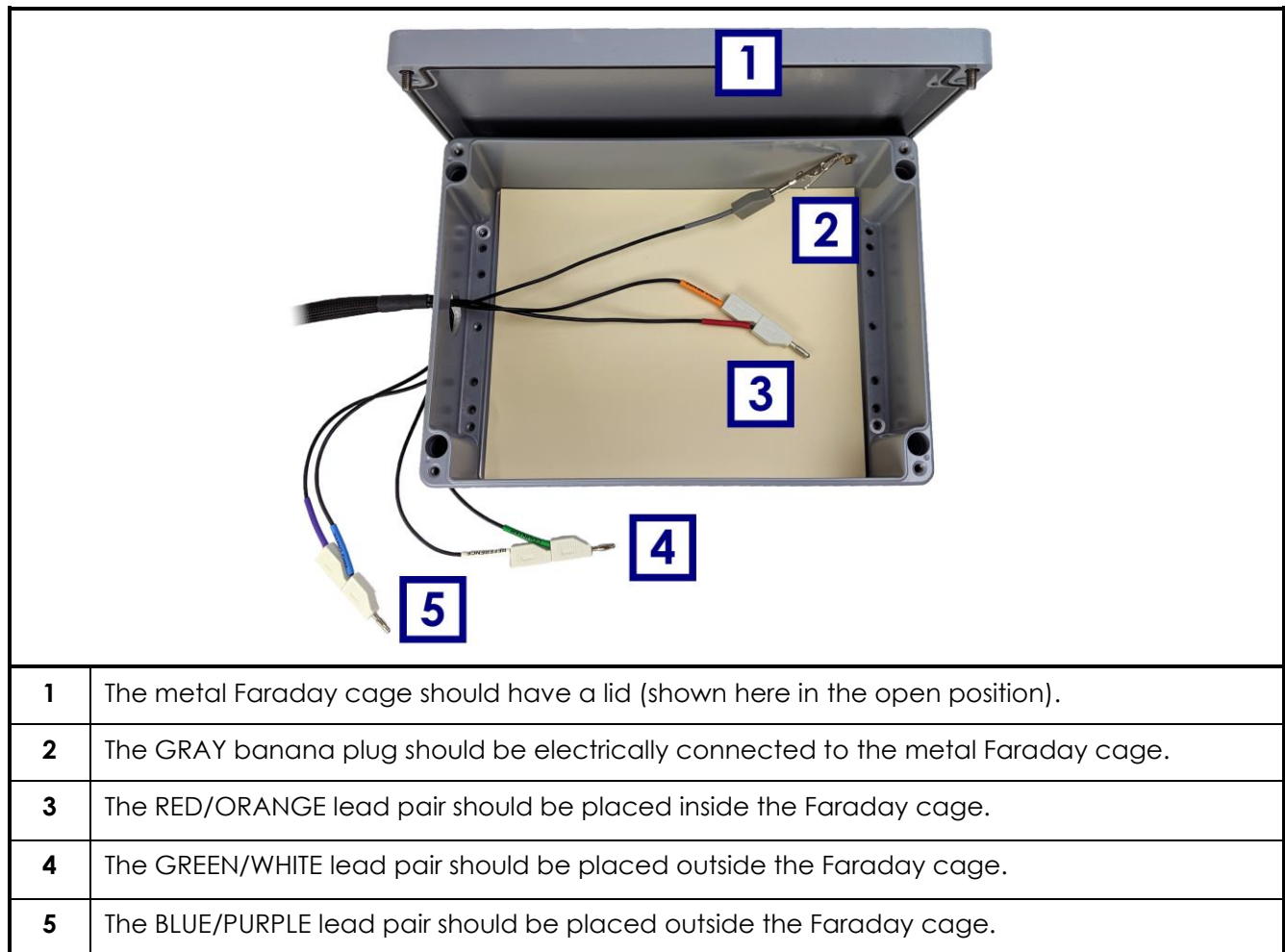

Figure 4-21. Proper Cable Arrangement for an Open Lead EIS Measurement

Position the GREEN/WHITE pair outside of the Faraday cage. Also position the BLUE/PURPLE pair outside of the Faraday cage. Verify that both pairs are not in contact with each other or with the Faraday cage or with any other conductive object.

Connect the GRAY cell cable banana plug directly to the metal Faraday cage. This electrically connects the instrument chassis to the Faraday cage, which is normally a good practice in any EIS experiment.



NOTE:

The “open lead” test result is very dependent upon the physical orientation of the cell cable. The test should be performed with the banana plugs placed inside a Faraday cage, and the Faraday cage should be directly connected to the instrument chassis. This test is meant as a diagnostic tool only and not as a concrete measurement of potentiostat accuracy.

1	Click on the “AutoFill” button. Note that default parameters for OCP Measurement Duration, AC Amplitude, DC Baseline, and Frequency Series appear automatically.
2	Set the OCP Measurement Duration to 1 s
3	Set the AC Amplitude to 50 mV
4	Set the DC Options Settle Period to 1 s

Figure 4-22. Parameters used for an Open Lead EIS Test

4.5.2 Create a Potentiostatic EIS Experiment (EIS-POT)

Choose the Potentiostatic Electrochemical Impedance Spectroscopy (EIS-POT) option from the AfterMath Experiments menu. Configure the EIS-POT specification as shown (see Figure 4-22).

4.5.3 Audit Experimental Parameters

Choose the WaveDriver 200 in the drop-down menu (see Figure 4-23, to the left of the “Audit” button). Press the “Audit” button to check the parameters. AfterMath will perform a quick audit of the parameter values to ensure that all required parameters have been specified and are within allowed ranges.

4.5.4 Initiate the Experiment

Click on the “Perform” button to initiate the EIS-POT Open Lead experiment. The “Perform” button is located to the right of the “Audit” button (see Figure 4-23).

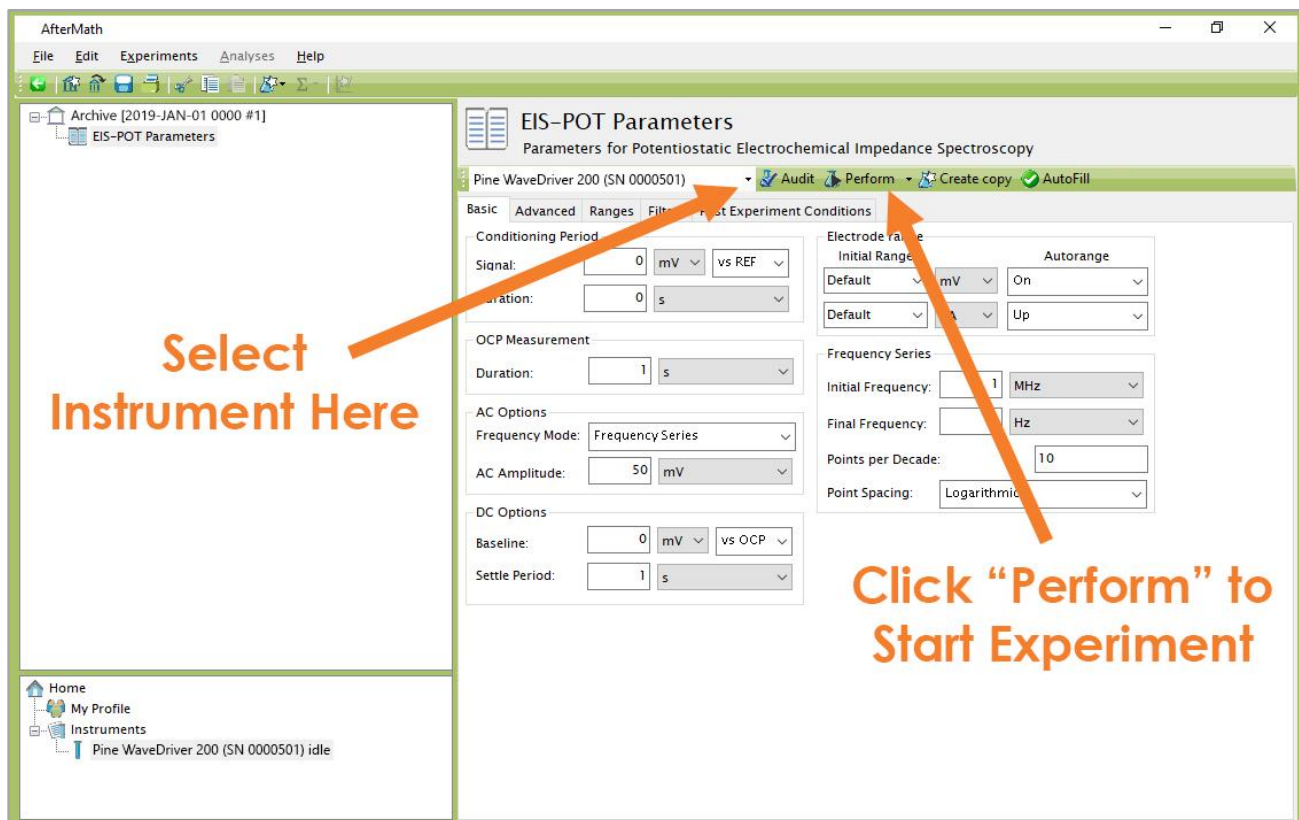

Figure 4-23. Location of Instrument Selection Menu and Perform Button (EIS-POT)

4.5.5 Monitor Experimental Progress

Monitor the progress of the experiment in AfterMath by observing the real time plot and the progress bar (see Figure 4-24). The default live display shows Lissajous plots, but Bode or Nyquist plots can also be observed in real time if desired.

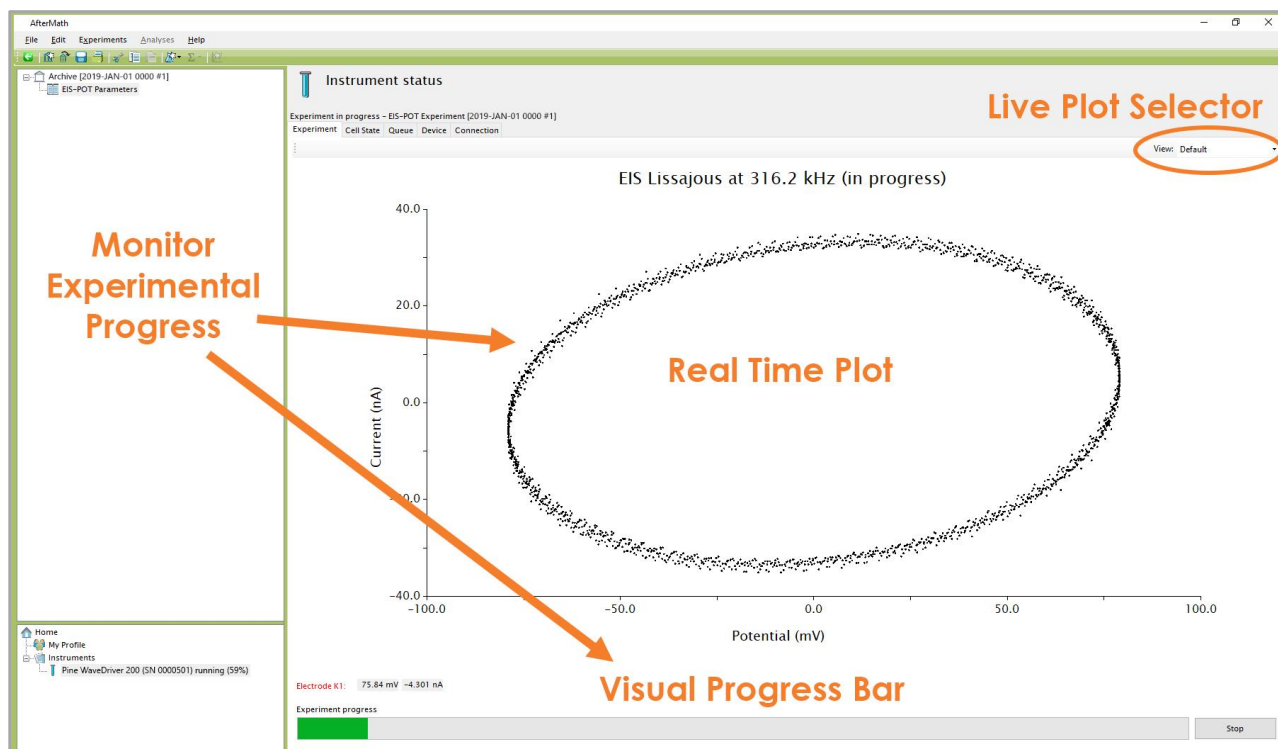

Figure 4-24. Monitoring the Progress of the EIS-POT Open Lead Experiment



NOTE:

During an EIS-POT experiment, the percentage complete value displayed at the bottom left portion of the screen refers to each individual frequency and is not indicative of the overall experimental progress.

4.5.6 Review the Results

When the experiment has finished, the results of the experiment are placed in a folder within the archive. The Bode plot is consistent with a nearly pure capacitive response, evidenced by the phase angle near -90° over a wide frequency range (see Figure 4-25). At low frequencies, high impedance ($\geq 100 \text{ G}\Omega$) results in low current and a poor signal-to-noise ratio, which appears as scatter in the Bode plot. Conversely, at high frequencies a “roll-off” effect is seen that is caused by parasitic inductive and capacitive effects in the cell cable.

The response observed in the Bode plot is indicative of a very small capacitive load (typically around 300 fF), and the highest impedance observed at low frequencies ($\leq 10 \text{ Hz}$) is about $100 \text{ G}\Omega$. These values are primarily useful as diagnostic benchmarks and represent the absolute minimum capacitance and maximum impedance measurement capabilities of the WaveDriver 200. Rather than relying upon open or shorted lead tests, the user should consult the Accuracy Contour Plot (see Figure 2-1) to determine practical measurement limits.

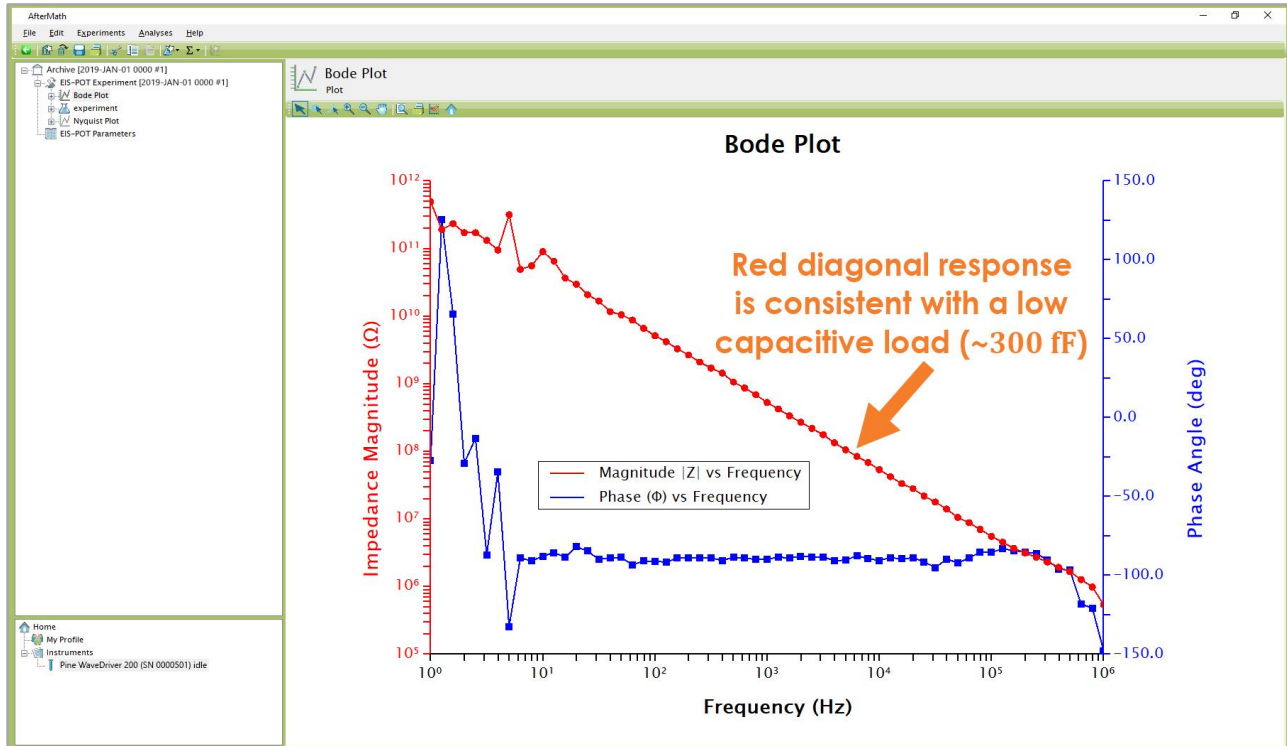

Figure 4-25. Bode Plot for a Typical Open Lead EIS Test



TIP:

Consult the WaveDriver 200 Accuracy Contour Plot (see Figure 2-1) for practical measurement limits. Open lead test data should not be considered as potentiostat accuracy limits.

4.6 Shorted Lead Test

A “shorted lead” test explores the absolute lower load measurement limit for EIS measurements across a range of frequencies. Measurements made at these extreme limits fall well outside the 5%, 5° region shown on the Accuracy Contour Plot (see Figure 2-1). The shorted lead test is a quick diagnostic test, and the results of the test should never be interpreted as a measurement of instrument accuracy.

4.6.1 Low Inductance Cell Cable Configuration

When measuring a low impedance load ($< 10 \Omega$), it is good practice to configure and route the cell cable in a manner that minimizes the inductance of the cell cable. Braiding the sense lines together and separately braiding the drive lines together (see Figure 4-26) minimizes the contribution of the cell cable inductance to the overall load measured by the instrument. Inductive interference from the cell cable is further minimized by maintaining as much separation between the drive lines and sense lines as possible.

The “load” used in a shorted lead test is a conductive material with very low impedance (typically a short length of copper wire or a conductive metal mesh). The load is essentially a “short circuit” with an

extremely small resistance ($\ll 1 \text{ m}\Omega$), so it is very important to use the low inductance (braided) cell cable configuration during a shorted lead test. In the example shown (see Figure 4-26), a conductive metal mesh is used as the load. Both of the sense lines – WHITE (reference) and ORANGE (K1 sense) – are physically braided together and clipped side-by-side to the mesh.



Figure 4-26. Braided Cell Cable Configuration for Low Inductance Load Measurement

Similarly, both of the drive lines – GREEN (counter) and RED (K1 drive) – are physically braided together, routed as far away from the sense lines as possible, and brought to the opposite side of the load. The RED lead (K1 drive) is clipped to the wire as close to the ORANGE lead (K1 sense) as possible. The GREEN lead (counter) is clipped to the wire as close to the WHITE lead (reference) as possible.

As is always good practice in any EIS experiment, the cables and the load are placed inside a metal Faraday cage (see Figure 4-27). The instrument chassis is connected to the Faraday cage by connecting the GRAY lead on the cell cable to any convenient connection point on the metal Faraday cage.



NOTE:

The “shorted lead” test result is greatly affected by the cell cable configuration and proper use of a Faraday cage. This test is a simple diagnostic tool and is not a measurement of potentiostat accuracy.

4.6.2 Create a Galvanostatic EIS Experiment (EIS-GAL)

Choose the Galvanostatic Electrochemical Impedance Spectroscopy (EIS-GAL) option from the Impedance Spectroscopy sub-menu in the AfterMath Experiments menu. A new EIS-GAL specification will be created and placed into a new archive. Configure the parameters as shown (see Figure 4-28).

4.6.3 Audit Experimental Parameters

Choose the WaveDriver 200 in the drop-down menu (see Figure 4-29, to the left of the “Audit” button). Press the “Audit” button to check the parameters. AfterMath will perform a quick audit of the parameter values to ensure that all required parameters have been specified and are within allowed ranges.

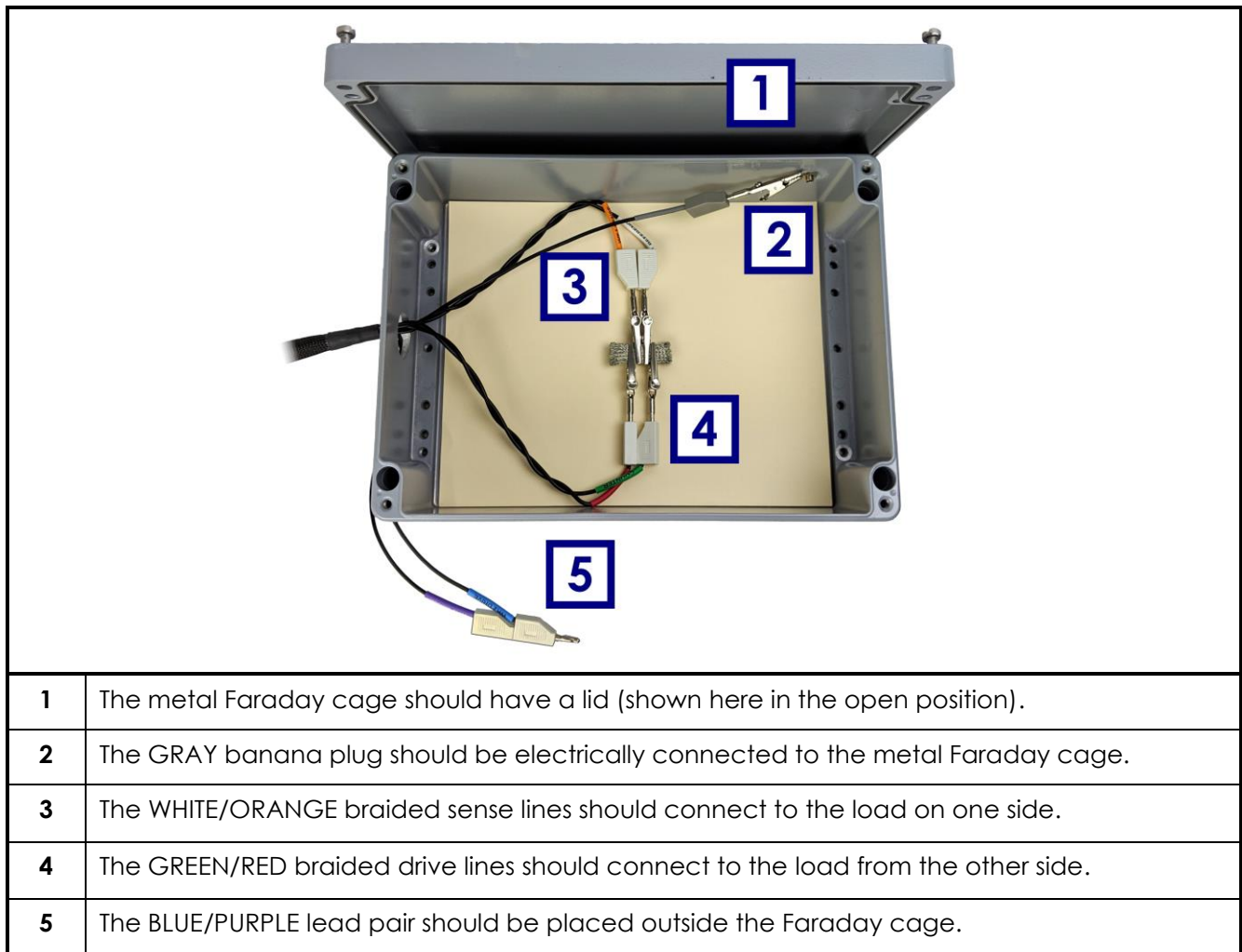

Figure 4-27. Proper Cable Arrangement for a Shorted Lead EIS Measurement

4.6.4 Initiate the Experiment

Click on the "Perform" button to initiate the EIS-GAL Shorted Lead experiment. The "Perform" button is located to the right of the "Audit" button (see Figure 4-29).

4.6.5 Monitor Experimental Progress

Monitor the progress of the EIS-GAL Shorted Lead experiment in AfterMath by observing the real time plot and the progress bar (see Figure 4-30). The default live display shows Lissajous plots, but Bode or Nyquist plots can also be observed in real time if desired.



NOTE:

During an EIS-GAL experiment, the percentage complete value displayed at the bottom left portion of the screen refers to each individual frequency and is not indicative of the overall experimental progress.

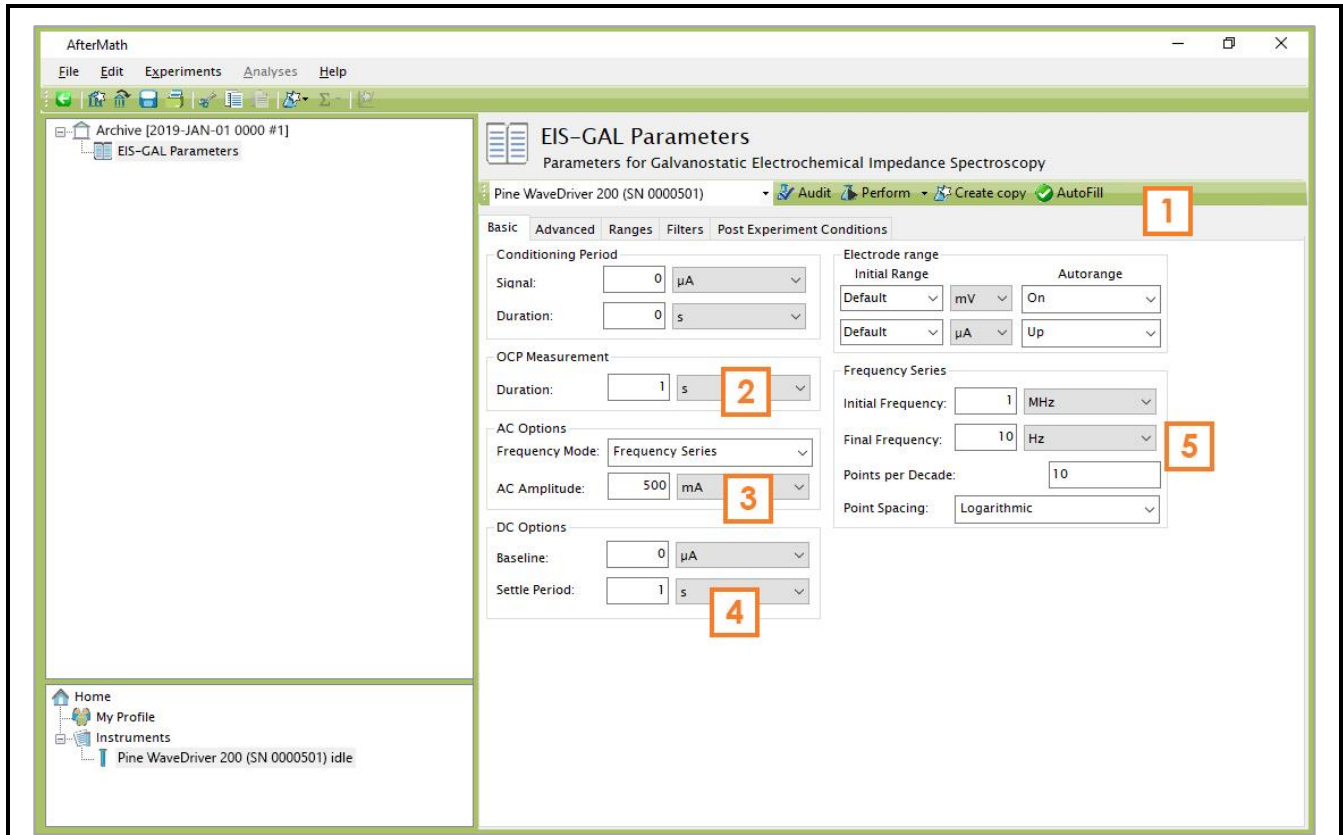

1	Click on the “AutoFill” button. Note that default parameters for OCP Measurement Duration, AC Amplitude, DC Baseline, and Frequency Series appear automatically.
2	Set the OCP Measurement Duration to 1 s
3	Set the AC Amplitude to 500 mA
4	Set the DC Options Settle Period to 1 s
5	Set the Final Frequency to 10 Hz

Figure 4-28. Parameters used for a Shorted Lead EIS Test

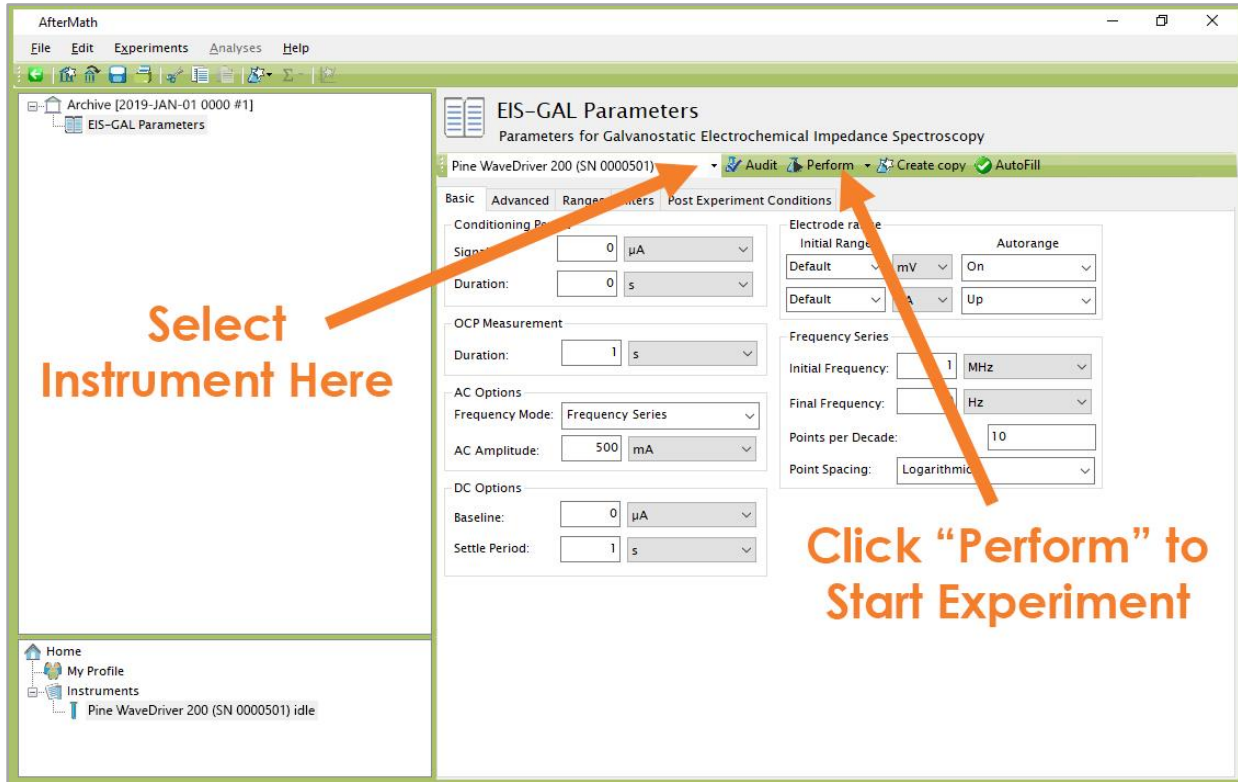

Figure 4-29. Location of Instrument Selection Menu and Perform Button (EIS-GAL)

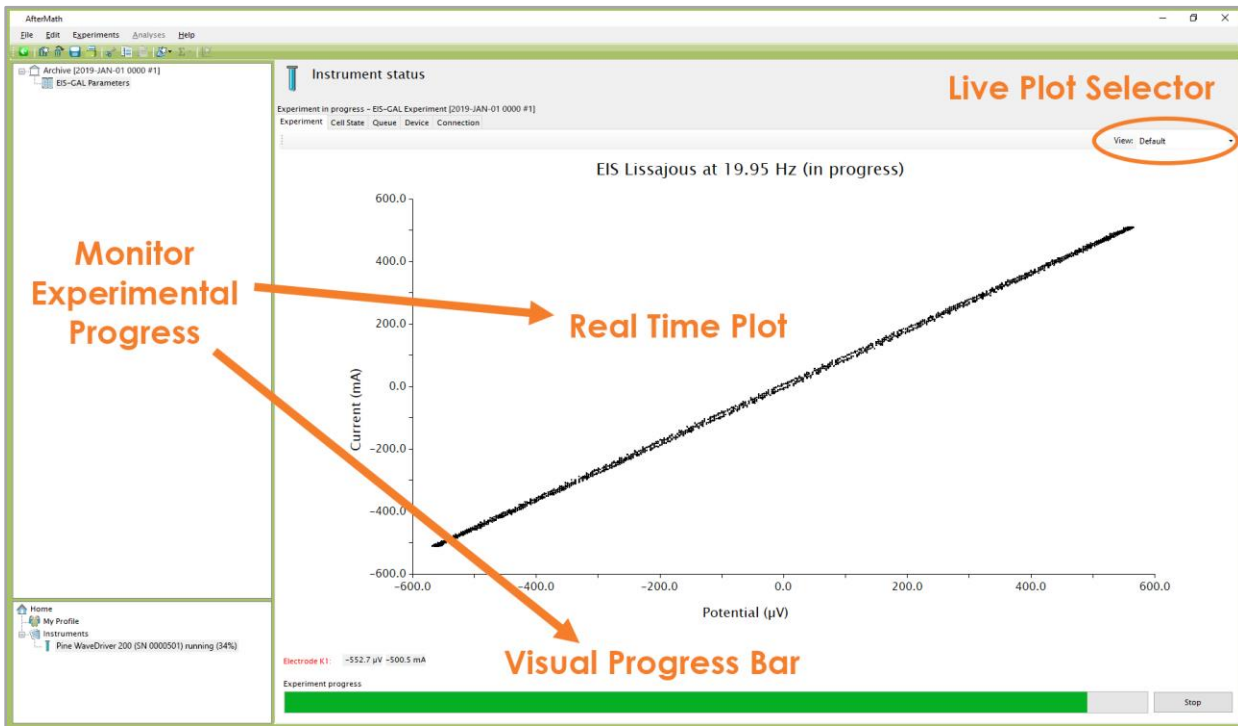

Figure 4-30. Monitoring the Progress of the EIS-GAL Shorted Lead Experiment

4.6.6 Review the Results

When the experiment has finished, the results of the shorted lead test are placed in a folder within the archive. Examination of the Bode plot (see Figure 4-31) at lower frequencies (≤ 50 Hz) shows how the load nearly behaves like an ideal resistor (*i.e.*, the phase angle is nearly zero) with a very small resistance ($\sim 250 \mu\Omega$).

This small resistance represents the lowest possible load measurement that can be made with the instrument, and it is related to the sum of the resistance of the cell cable leads, the contact resistance of the alligator clips with the load, and the small resistance of the load itself. This minimal residual resistance falls well below the range of impedance loads normally encountered in routine EIS experiments, and it also falls below the lower limit of the Accuracy Contour Plot (see Figure 2-1). Nevertheless, the user may wish to measure this residual resistance and subtract it from EIS results in those cases where the load being studied is quite small ($\leq 20 \text{ m}\Omega$).

As the frequency increases, the Bode plot shows a gradual increase in the observed load as the phase angle increases toward ninety degrees ($+90^\circ$). The inductive properties of the cell cable begin to dominate at higher frequencies, imposing an extreme limit (*e.g.*, "the inductive limit") beyond which the instrument cannot make a measurement. Again, this extreme limit falls well outside the accuracy limits shown on the Accuracy Contour Plot (see Figure 2-1).

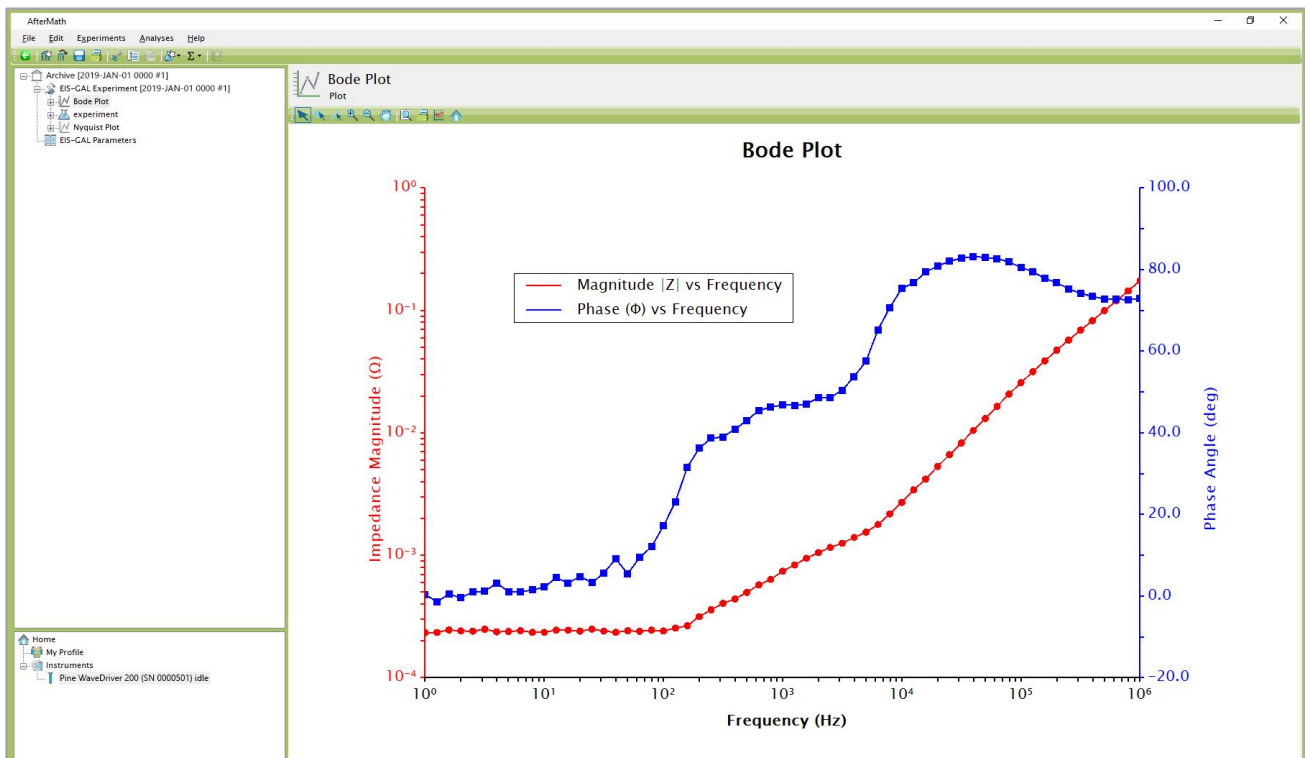

Figure 4-31. Bode Plot for a Typical Shorted Lead EIS Test

4.7 Simple EIS Test

This test simulates the EIS response of a real electrochemical system involving inductive, resistive, and capacitive elements. A representative circuit containing these elements is built into the Pine Research Universal Dummy Cell and may be used to test the EIS functionality of the WaveDriver 200 as well as the circuit fitting tools available in the AfterMath software package.

4.7.1 Connect to the Pine Research Universal Dummy Cell



NOTE:

If using the legacy EIS Calibration & Dummy Cell (Pine Research part number AFDUM5) that was included with a WaveDriver 200 purchased before November 2020, refer to corresponding instructions in Section 10.4.

Connect the WaveDriver 200 cell cable leads to the Pine Research Universal Dummy Cell in identical fashion to the previous Single Channel DC Test (see Section 4.2.1 for connection instructions), except the leads should be connected to the side labeled “EIS” (see Figure 4-32 for illustration).

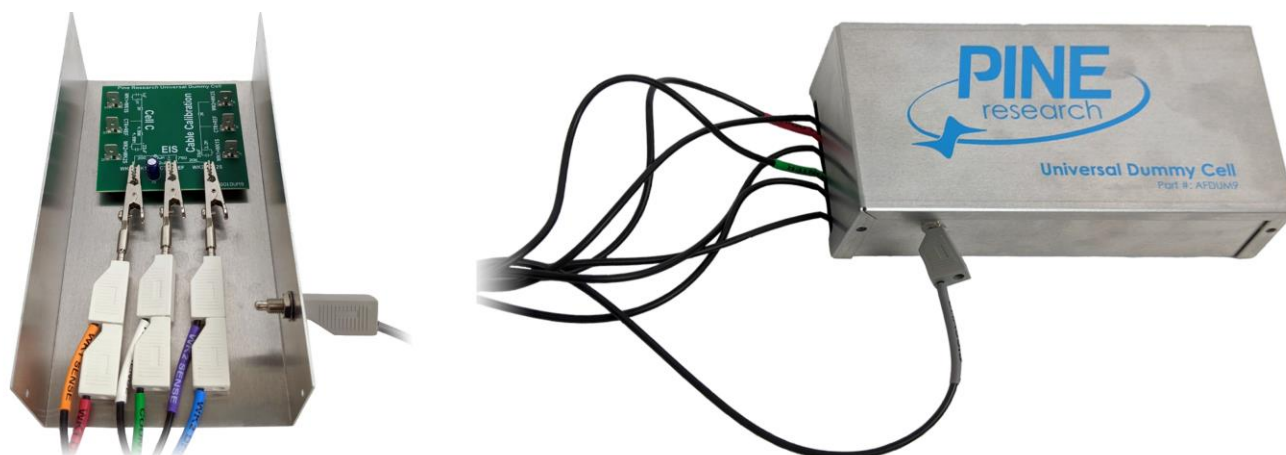

Figure 4-32. WaveDriver 200 Cell Cable Connected to “EIS” on Dummy Cell

4.7.2 Create a Potentiostatic EIS Experiment (EIS-POT)

Choose the Potentiostatic Electrochemical Impedance Spectroscopy (EIS-POT) option from the Impedance Spectroscopy sub-menu in the AfterMath Experiments menu. A new EIS-POT specification will be created and placed into the archive. Configure the parameters as shown (see Figure 4-33).

4.7.3 Audit Experimental Parameters

Choose the WaveDriver 200 in the drop-down menu (see Figure 4-34, to the left of the “Audit” button). Press the “Audit” button to check the parameters. AfterMath will perform a quick audit of the parameter values to ensure that all required parameters have been specified and are within allowed ranges.

4.7.4 Initiate the Experiment

Click on the "Perform" button to initiate the EIS-POT experiment. The "Perform" button is located to the right of the "Audit" button (see Figure 4-34).

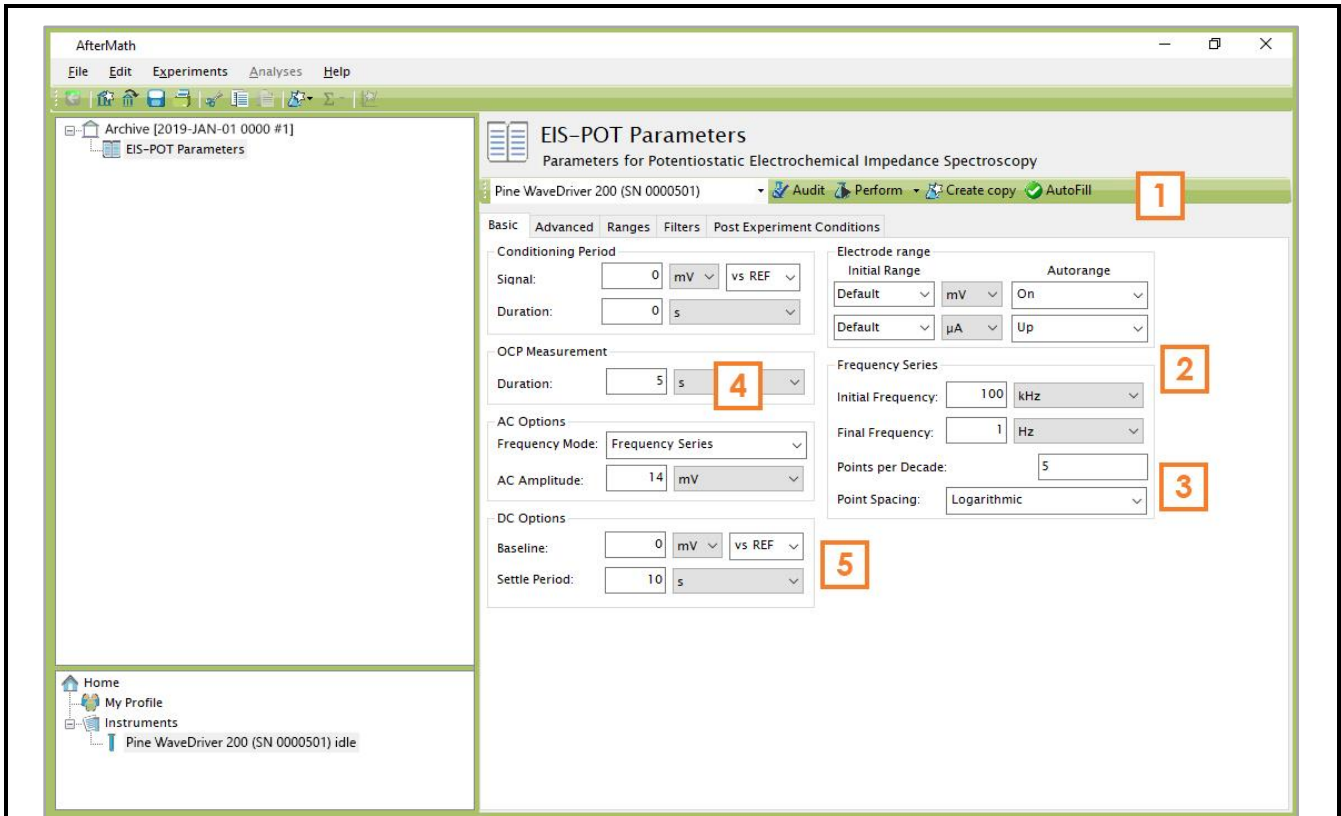

1	Click on the "AutoFill" button. Note that default parameters for OCP Measurement Duration, AC Amplitude, DC Baseline, and Frequency Series appear automatically.
2	Set the Initial Frequency to 100 kHz; set the Final Frequency to 1 Hz
3	Set the Points per Decade to 5
4	Set the OCP Measurement Duration to 5 s
5	Set the DC Options Settle Period to 10 s and change the Baseline to "vs REF"

Figure 4-33. Experimental Parameters for a Simple EIS Test

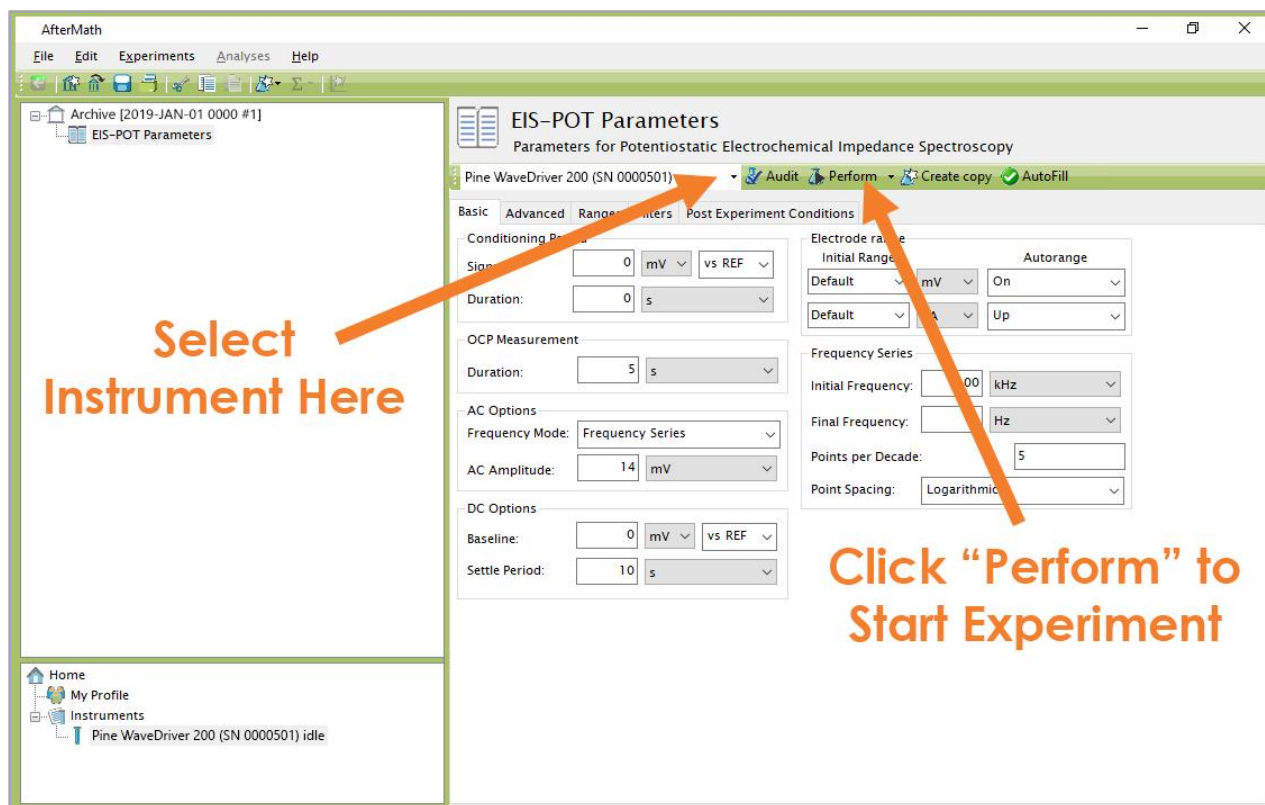

Figure 4-34. Location of Instrument Selection Menu and Perform Button (EIS-POT)

4.7.5 Monitor Experimental Progress

Monitor the progress of the EIS-POT Simple AC Test experiment in AfterMath by observing the real time plot and the progress bar (see Figure 4-35). The default live display shows Lissajous plots, but Bode or Nyquist plots can also be observed in real time if desired. Data is automatically updated on these additional plots in real time as the experiment progresses.



NOTE:

During an EIS-POT experiment, the percentage complete value displayed at the bottom left portion of the screen refers to each individual frequency and is not indicative of the overall experimental progress.

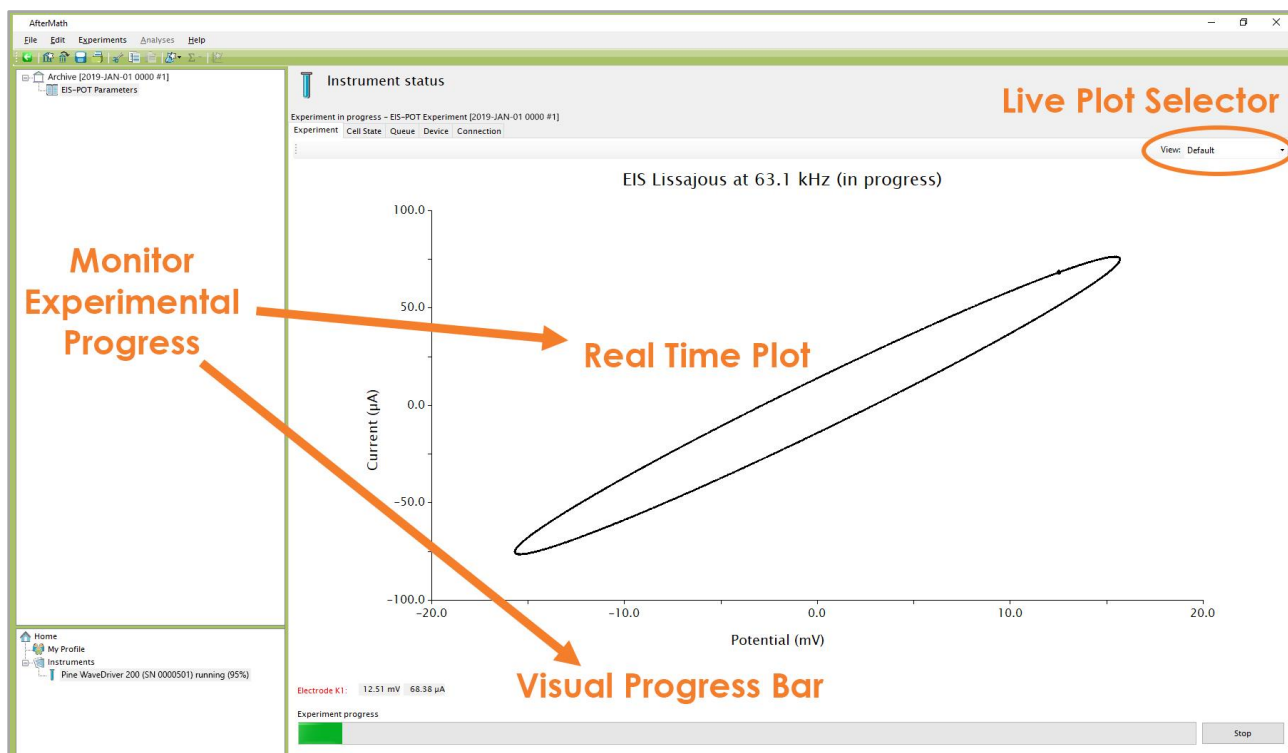

Figure 4-35. Monitoring the Progress of the EIS-POT Simple AC Test Experiment

4.7.6 Review the Results

When the experiment has finished, the results of the experiment are placed in a folder within the archive (see Figure 4-36 and Figure 4-37). In addition to the Bode and Nyquist plots that are automatically populated after an EIS-POT experiment has completed, additional data can be viewed in the “results” node under the “experiment” node of the EIS-POT experiment (see Figure 4-38). Tabular data can be selected from the drop-down list for all typical EIS parameters, as well as Conditioning Period, Measured OCP, DC Settling Period, and Lissajous results for all applied frequencies. If desired, graphical plots can also be quickly generated for any of the aforementioned tabular data by clicking the “Create Plot” button (see Figure 4-38).

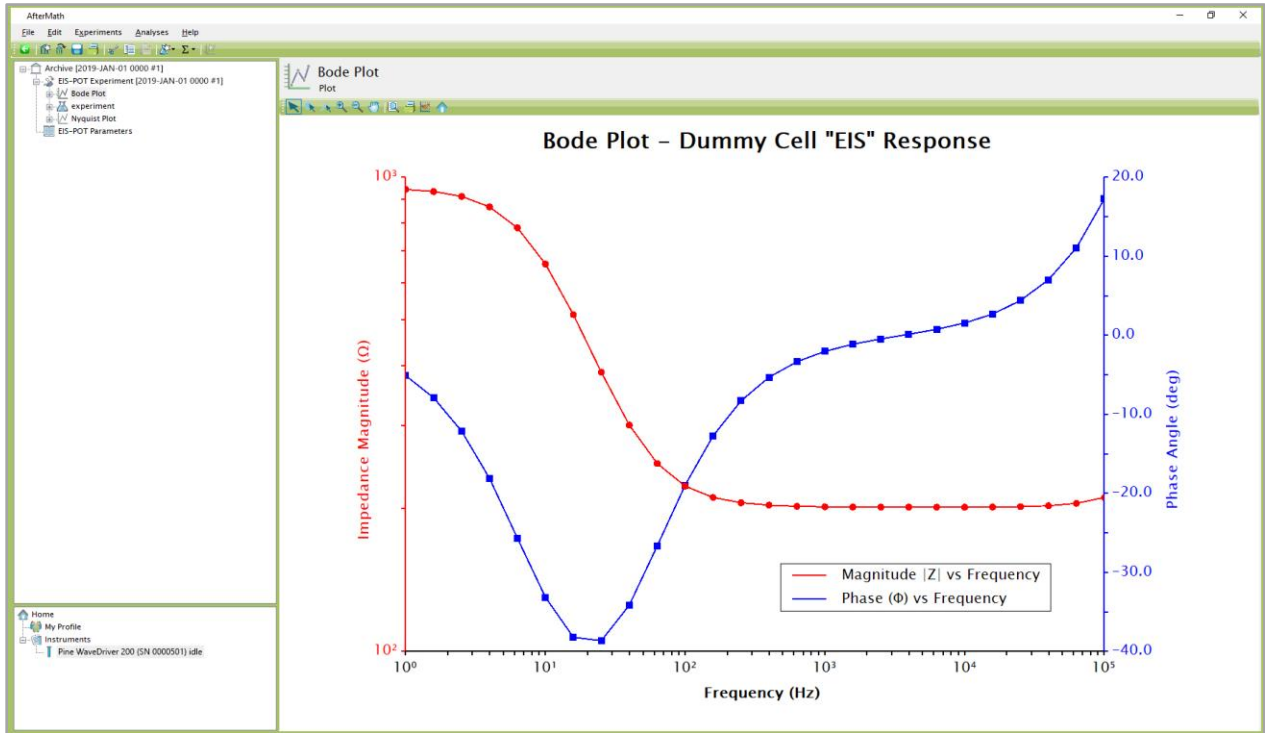

Figure 4-36. Anticipated EIS-POT Results – Bode Plot (using “EIS” on Dummy Cell)

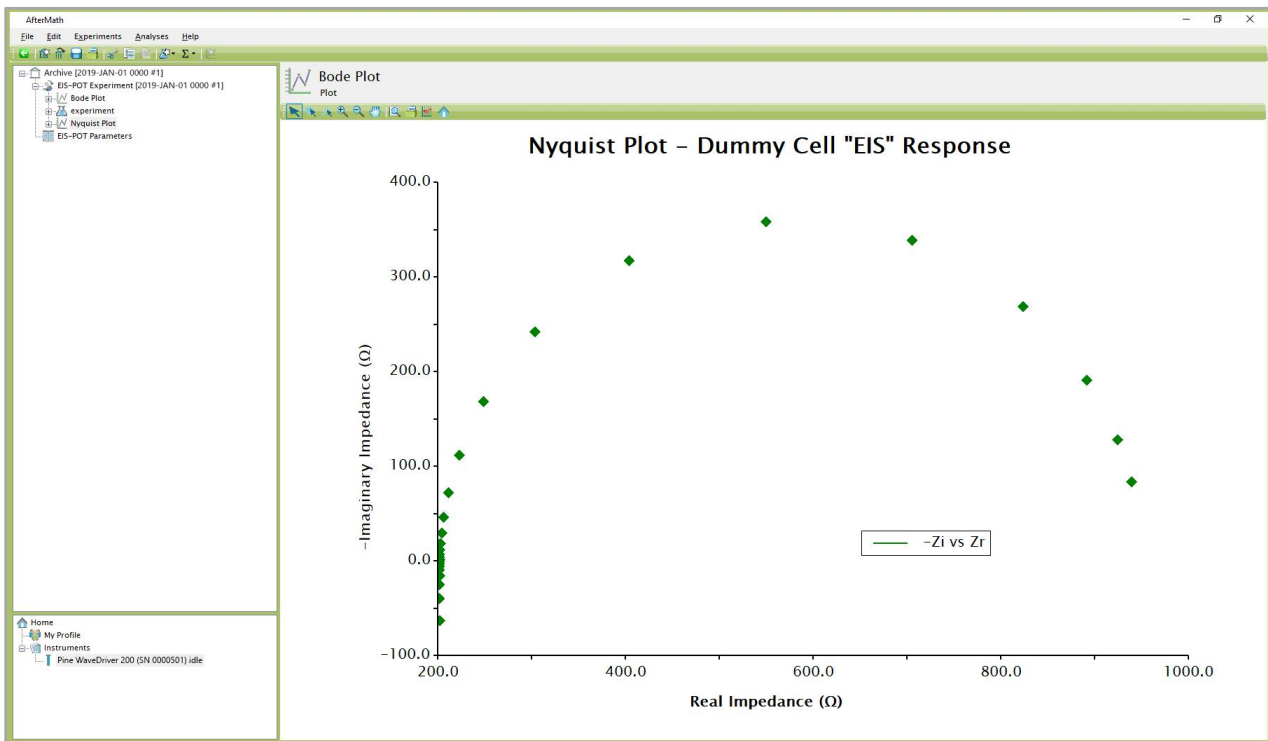

Figure 4-37. Anticipated EIS-POT Results – Nyquist Plot (using “EIS” on Dummy Cell)

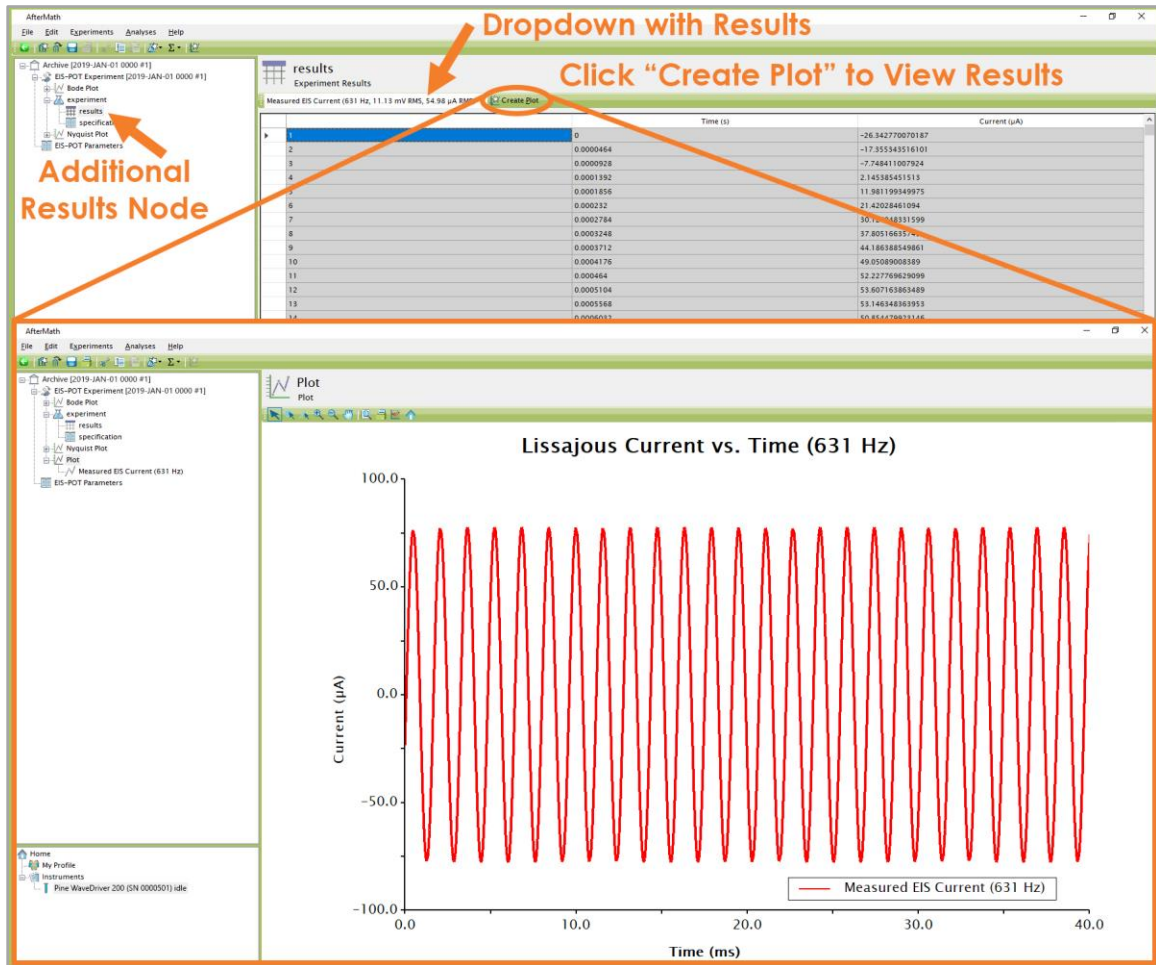

Figure 4-38. Additional Results Node from EIS-POT Simple AC Test Experiment

4.7.7 Understanding the Results

The representative circuit on the “EIS” side of the Pine Research Universal Dummy Cell contains inductive, resistive, and capacitive elements (see Section 2.8 for circuit schematic). A leading resistor ($200\ \Omega$) and inductor ($100\ \mu\text{H}$) represent the uncompensated resistance and inductance that may be present in an actual electrochemical cell. The EIS response observed in the Bode Plot at high frequencies ($> \sim 3\ \text{kHz}$) shows how the leading inductor generates a positive (inductive) phase angle while the observed impedance magnitude ($\sim 200\ \Omega$) is largely due to the leading resistor (see Figure 4-36). The influence of the leading inductor is also evident in the Nyquist plot where a negative imaginary impedance is observed (see Figure 4-37). The intercept with the real impedance axis ($\sim 200\ \Omega$) is mainly due to the leading resistor.

In the middle-to-low frequencies on the Bode Plot (between $\sim 3\ \text{kHz}$ and $1\ \text{Hz}$), the parallel resistor ($750\ \Omega$) and capacitor ($22\ \mu\text{F}$) generate a dip to negative (capacitive) phase angle values as well as an increase in the impedance magnitude. This resistor and capacitor in parallel (i.e., a “parallel RC” element) leads to a characteristic semicircle shape in the Nyquist plot (see Figure 4-37). The width of this semicircle (measured along the horizontal axis) is a measure of the resistance in the parallel RC element ($\sim 750\ \Omega$).

4.7.8 Performing a Circuit Fit Analysis

A Circuit Fit Analysis can be performed on the results to verify the circuit element parameters. Highlight an entry within the EIS-POT experiment in AfterMath and click on either “Analyses” or the “ Σ ” symbol at the top of the screen and select the “Circuit Fit” option from the menu (see Figure 4-39).

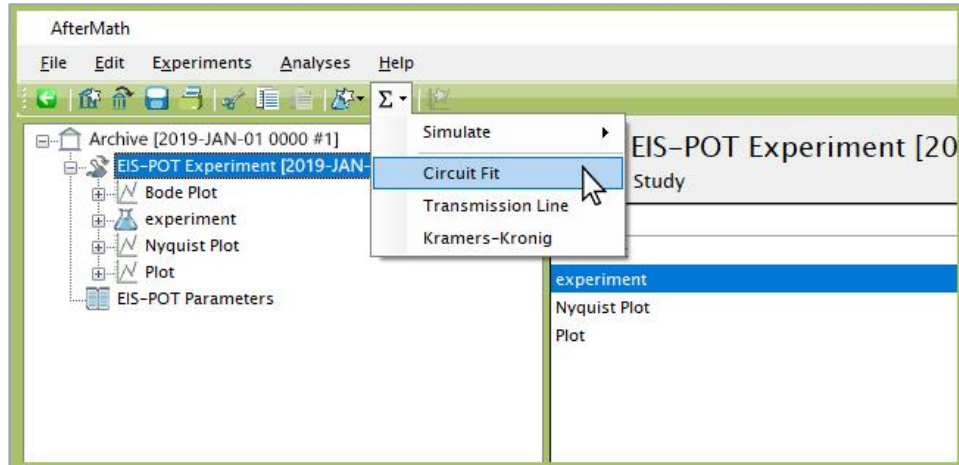

Figure 4-39. Location of Circuit Fit Analysis in AfterMath

A new Circuit Fit Analysis will be added to the archive. Choose the circuit in the “Built-In Circuits” library that has the title “L1sR1s(Q1pR2)” (see Figure 4-40). The circuit schematic diagram will appear to the right of the list. Click the box labeled “OK” to choose this circuit.

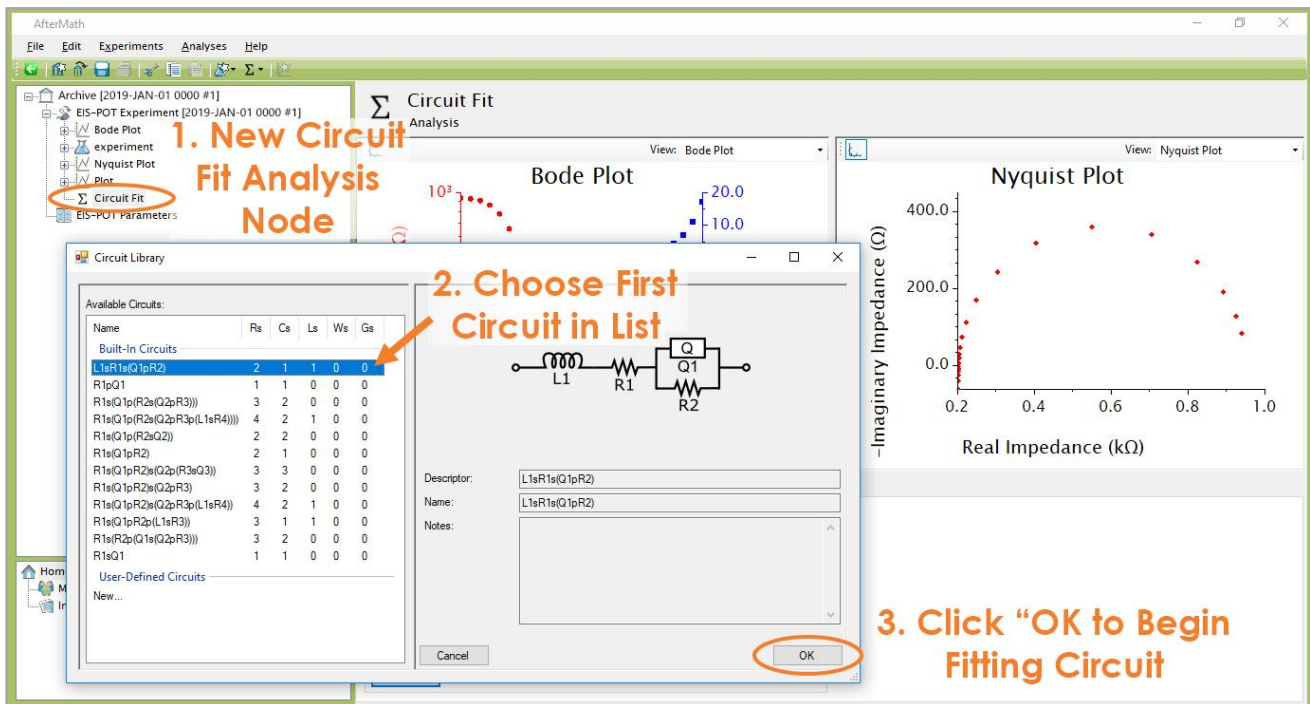

Figure 4-40. Circuit Library Selection for Circuit Fit Analysis

**TIP:**

In AfterMath circuit model syntax, an “s” between two elements indicates a series connection and a “p” indicates a parallel connection. “L” represents an inductor, “R” represents a resistor, and “Q” represents a constant phase element.

Circuit elements are numbered uniquely and sequentially. Additionally, the order of connections follows standard mathematical parentheses rules. For more detailed information on circuit model syntax and user-defined circuits in AfterMath, please consult the knowledgebase:

<https://www.pineresearch.com/shop/knowledgebase/>

Once the circuit has been selected, AfterMath chooses suitable initial “seed” values for each of the circuit parameters, and then the circuit fit is also automatically performed. The Bode and Nyquist Plots on the display are updated to overlay the circuit fit results (computed values) on top of the original experimental data. In some cases, the initial values are sufficient to provide a satisfactory fit (see Figure 4-41). The user may also view all fitted parameter values along with associated uncertainties on the Calculated Values tab (see Figure 4-42).

While the automatically-calculated fit is often acceptable, occasionally it is necessary to iteratively refine the fitted parameter values. AfterMath provides an easy way to accomplish this task. Ideally, each successive iteration moves the parameter values closer to a better overall fit. AfterMath also provides several different fitting methods and weighting options, and sometimes it is helpful to toggle these settings while searching for the best fit. Trial-and-error using multiple fitting methods and weighting options is sometimes required to obtain a satisfactory fit.

To iterate further without changing the fitting method, simply use the “Calculate Fit” button on the Initial Values tab, or the “Calculate More” button on the Calculated Values tab (in conjunction with the “Max Iterations” parameter), to apply as many additional iterations as desired. If further iterations do not appear to refine the overall fit, then it may be necessary to change the fitting method or weighting option being used. To do this, press the “Copy Results to Initial Values” button located on the Calculated Values tab (see Figure 4-42). This copies the most recent fit results back to the Initial Values tab and allows the fitting method and/or weighting option to be changed. Several fitting methods (Levenberg-Marquardt, Simplex, and Powell) and weighting options (Parametric, Unity, Custom) are available.

4.7.9 Saving the Fitting Results

For the representative circuit on the “EIS” side of the Pine Research Universal Dummy Cell, the circuit fitting process should converge quickly on a good fit after a few iterations. Each of the parameter values produced by the fitting process can be compared to the known values for the resistors, capacitor, and inductor in the representative circuit (see Section 2.8 for schematic).

After the fitting process converges on a satisfactory result, the values of the fitting parameters may be copied to the system clipboard using the “Copy Results to Clipboard” button located on the Calculated Values tab (see Figure 4-42). In addition, duplicate copies of the Bode and Nyquist plots can be copied to the archive by right-clicking the plots and choosing the “Duplicate Plot” option.

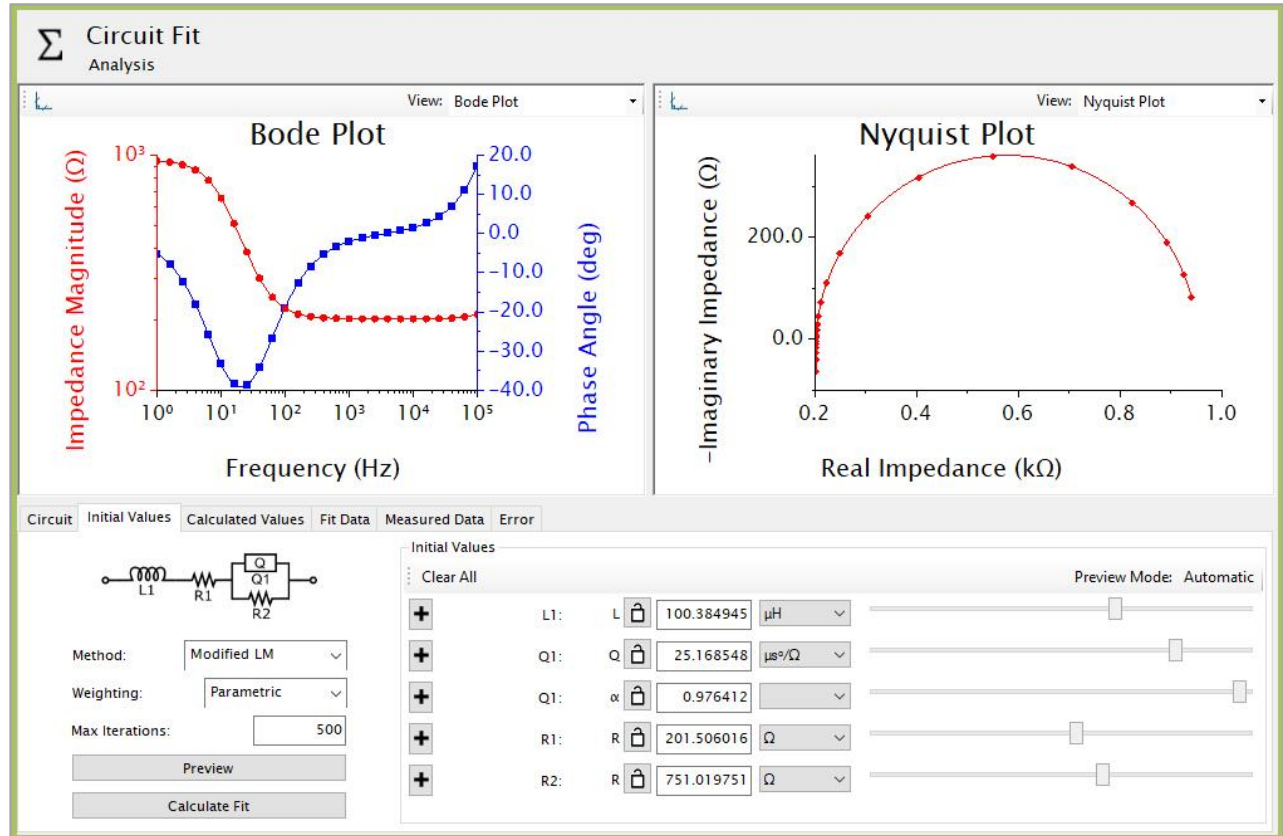

Figure 4-41. Circuit Fit Analysis Results for EIS Dummy Cell

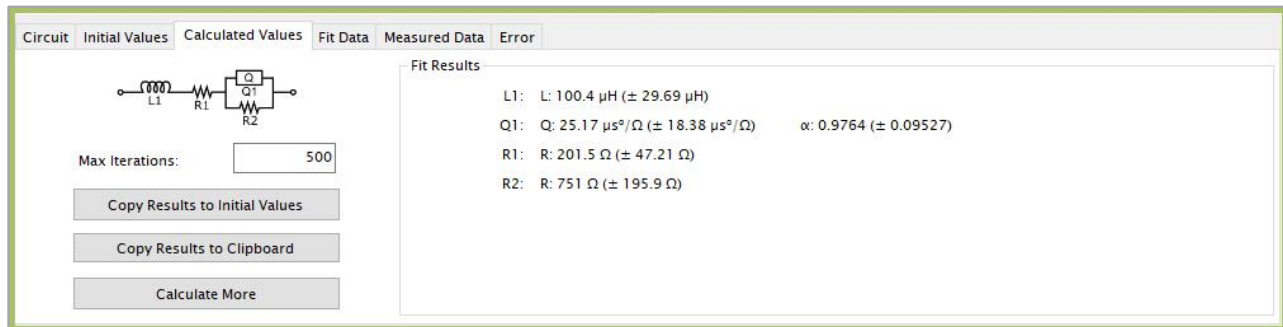

Figure 4-42. Circuit Fit Calculated Values Tab with Parameter Values and Uncertainties

5. Cell Cable Connections

This section describes how to connect several different kinds of electrochemical cells to the WaveDriver 200. Before proceeding, the user should be familiar with general concepts associated with electrochemical cells and experimentation. Using the WaveDriver 200 Cell Cable (part number ACP3E01), connections can be made to simple two-terminal cells (such as batteries, fuel cells, solar cells, amperometry sensors, capacitors, resistors, and inductors), traditional three-electrode voltammetry cells (including those that contain a rotating disk electrode or a rotating cylinder electrode), compact voltammetry cells, and to more complex dual working electrode cells (including rotating ring-disk electrode cells).

5.1 Cell Cable Color Code

The front panel of the WaveDriver 200 has a large cell connection port containing several signal lines that may be connected to the various working, counter, and reference electrodes that may be present in an electrochemical cell. It is important to understand that some of the signal lines are low impedance DRIVE lines while others are high impedance SENSE lines. In general, the DRIVE lines are used to drive current through the electrochemical cell while the SENSE lines are used to carefully measure the potential at various electrodes.



NOTE:

DRIVE lines are low impedance lines used to drive current.

SENSE lines are high impedance lines used to measure potential.

The WaveDriver 200 Cell Cable breaks out the cell port connections to six shielded coaxial lines and one unshielded line (the GRAY instrument chassis line). The shielded coaxial lines terminate in banana plugs that are designed to be stacked as needed and directly connected to electrodes. Alligator clips that slide onto the banana plugs are included. A tabular summary of the color code for these lines is provided (see Table 5-1).

Color	Description	ID	Type
WHITE	Reference Electrode	REF	Sense
GREEN	Counter Electrode	CTR	Drive
GRAY	Instrument Chassis		Ground
RED	Primary Working Electrode (K1)	WK1	Drive
ORANGE	Primary Working Electrode (K1)		Sense
BLUE	Secondary Working Electrode (K2)	WK2	Drive
VIOLET	Secondary Working Electrode (K2)		Sense

Table 5-1. WaveDriver 200 Cell Cable Color Description

The instrument chassis lead is often connected to a Faraday cage surrounding the electrochemical cell. Less commonly used ground connections are also available (see Figure 5-1).

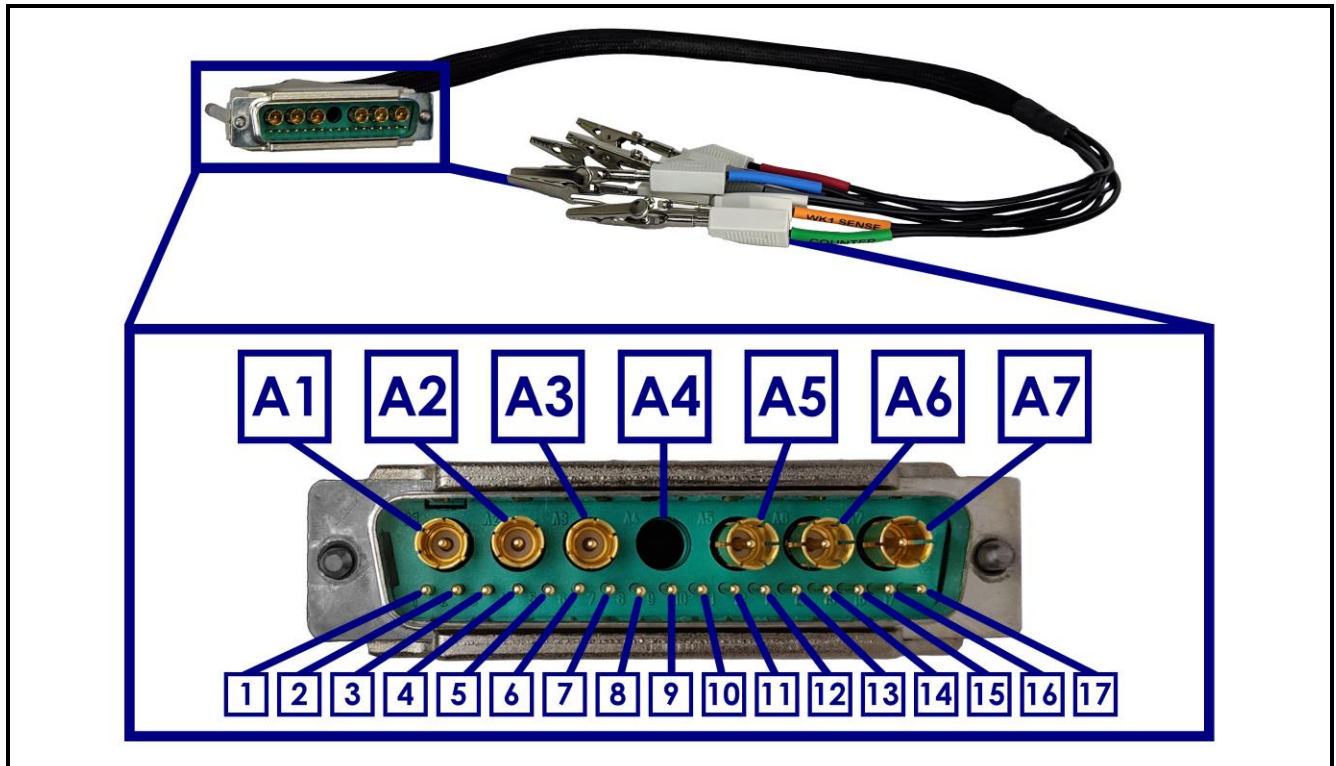

Pin	Signal	Pin	Signal
A1	Counter (CTR)	6	DC Common
A2	Working Sense 2 (K2) – includes terminating resistor	7	Cable Identification
A3	Working Drive 2 (K2)	8	
A4	Unused	9	
A5	Reference Sense (REF) – includes terminating resistor	10	
A6	Working Drive 1 (K1)	11	Unused
A7	Working Sense 1 (K1) – includes terminating resistor	12	
1	Analog Ground	13	
2	Unused	14	
3	Chassis Connection	15	
4		16	
5	Unused	17	

Figure 5-1. WaveDriver 200 Cell Port and Cell Cable Pinout



NOTE:

The high input impedance SENSE lines carry only very small currents during normal operation. Each of these SENSE lines is terminated with a resistor embedded within the banana plug at the end of the cable.

5.2 Experimental Configurations

With the proper cell cable configuration, several kinds of electrochemical systems can be connected to the WaveDriver 200. The following discussion of cell cable configurations assumes prior familiarity with the concepts associated with each type of electrochemical cell.

The WaveDriver 200 Cell Cable has a D-Shell connector that fits the cell cable port located on the front panel of the instrument. There are two thumbscrews on the D-Shell connector that tighten into the cell cable port to provide a secure connection (see Figure 5-2).



Figure 5-2. Secure Connection of the WaveDriver 200 Cell Cable to the Cell Port

As the cell cable emerges from the D-Shell connector, a conductive mesh shield runs along most of the length of the cable. This mesh shield is electrically connected to the chassis of the instrument and provides additional protection from environmental noise and ESD events.

At the cell end of the cable, multiple signal lines emerge from the mesh sleeve and terminate in banana plugs. All of these signal lines (except for the GRAY chassis line) are coaxial. The outer (shield) portion of each coaxial line further protects sensitive signals from environmental noise. Alligator clips (included) may optionally be installed on the banana plugs as needed.

When the WaveDriver 200 is not being used as a bipotentiostat (i.e., when there is not a second working electrode present in the cell), the banana plugs for the BLUE and VIOLET leads should be stacked together and set aside (see Figure 5-3). To prevent these leads from coming into contact with any conductive surface, they can optionally be placed inside a plastic bag.



Figure 5-3. Unused K2 Electrode Lines



TIP:

Whenever the K2 electrode connections (BLUE and VIOLET) are not in use, short these banana plugs together and set them aside (see Figure 5-3).

5.2.1 Two-Electrode Setups

Typical examples of two-electrode setups are solid-state experiments that probe electrochemical behavior across a single interface, experiments that involve ion-selective electrodes (where the open circuit potential is measured between an ion-selective electrode and a reference electrode), and rechargeable batteries consisting of an anode and cathode. Simple experiments with common electronic components (resistors, capacitors, and inductors) also use a two-electrode arrangement (see Figure 5-4).

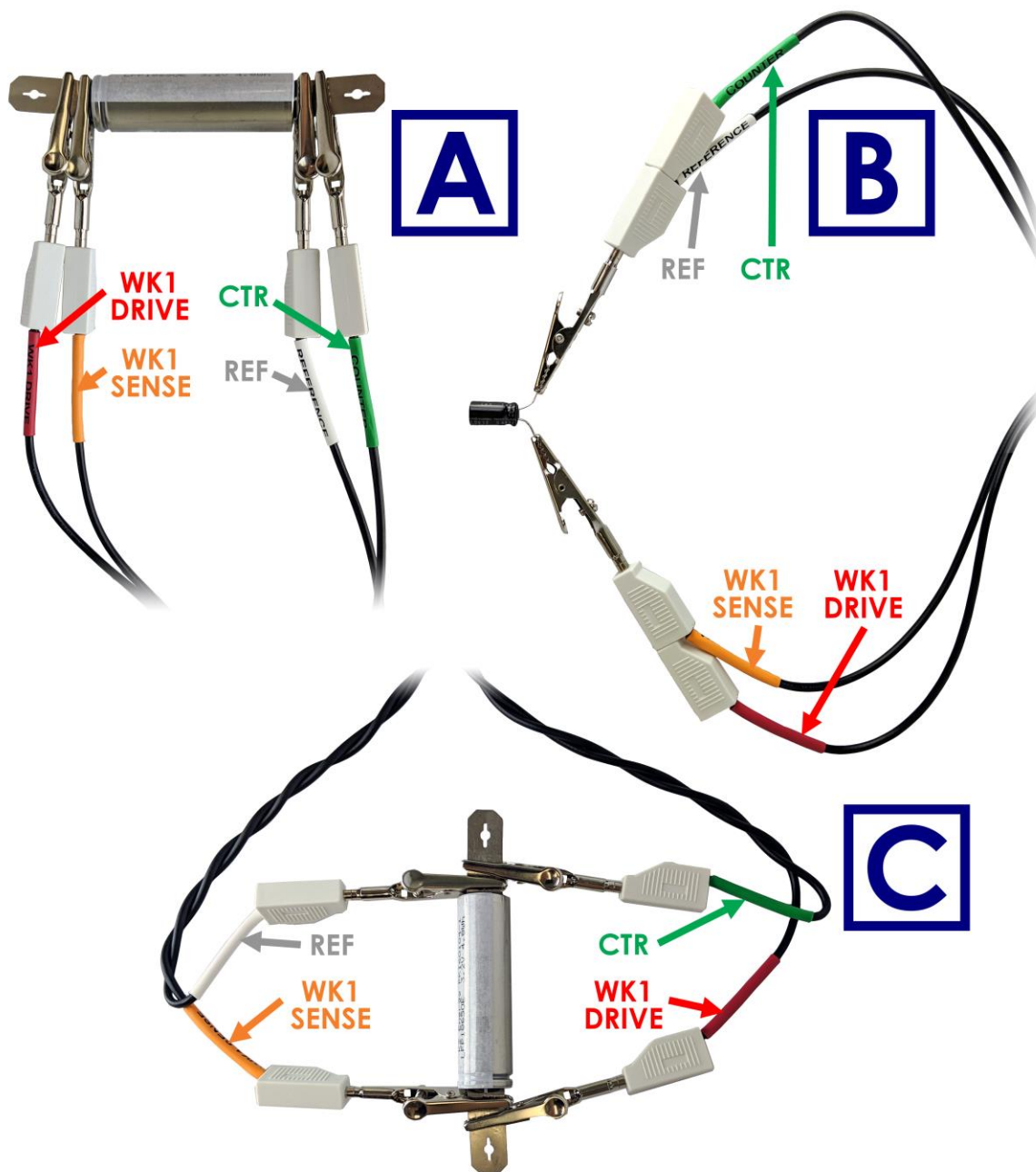

Figure 5-4. Examples of Two-Electrode Setups

The WaveDriver 200 Cell Cable can be configured for two-electrode experiments in a few different ways depending on the impedance of the system under study. For measured impedances around $1\text{ k}\Omega$, it is acceptable to simply stack together two pairs of banana plugs. The banana plugs for the GREEN (counter electrode) and WHITE (reference electrode) leads are stacked together to form the first pair, and the banana plugs for the RED and ORANGE leads (K1 electrode drive and sense) are stacked together to form the second pair (see Figure 5-4, B). One pair of shorted leads is connected to one of the electrodes in the system, and the other pair is connected to the opposite electrode. Alternatively, each pair of leads can also be individually clipped to either electrode without stacking the banana plugs if desired (see Figure 5-4, A).

When working with a low impedance load ($\sim 10\ \Omega$), cable inductance effects can be minimized by separately twisting the sense lines (ORANGE K1 sense and WHITE reference) and drive lines (RED K1 drive and GREEN counter) together (see Figure 5-4, C). The distance between the two sense lines (ORANGE and WHITE) should also be minimized as much as possible, and all connections should be closely spaced and secure to avoid added resistance from long electrode wires or leads. This is also the preferred configuration to use when performing a shorted lead test (see Section 4.6).

When working with a high impedance load (above $\sim 10\text{ k}\Omega$), cable capacitance effects can be minimized by separating the RED and ORANGE lines from the GREEN and WHITE lines as much as possible (see Figure 5-4, B). This is also the preferred configuration to use during an open lead test (see Section 4.5).

Using the recommended two-electrode polarity convention, the GREEN/WHITE pair should be connected to whichever electrode is considered to be the reference electrode. This convention assures that when the software applies a positive potential to the working electrode, the RED/ORANGE pair is more positive than the GREEN/WHITE "reference" pair. For example, when connecting to a battery or fuel cell, the positive electrode (cathode) should be considered the working electrode and connected to the RED/ORANGE pair while the negative electrode (anode) should be connected to the GREEN/WHITE pair. This will ensure the proper current and voltage conventions are observed when performing charge/discharge or polarization curve experiments.

When working with a simple two-electrode cell, the second working electrode (K2) drive and sense lines (BLUE and VIOLET lines) are not used. These leads should be shorted together and set aside (see Figure 5-3). These lines are meant for use only with dual working electrode experiments such as those involving a rotating ring-disk electrode (see Section 5.2.4).

5.2.2 Three-Electrode Cells

In a traditional three-electrode cell, three different electrodes (working, counter, and reference) are placed in the same electrolyte solution. During three-electrode experiments, charge flow (current) primarily occurs between the working electrode and the counter electrode while the potential of the working electrode is measured with respect to the reference electrode. The WaveDriver 200 Cell Cable can be configured for three-electrode experiments by appropriate connection of the drive and sense lines.

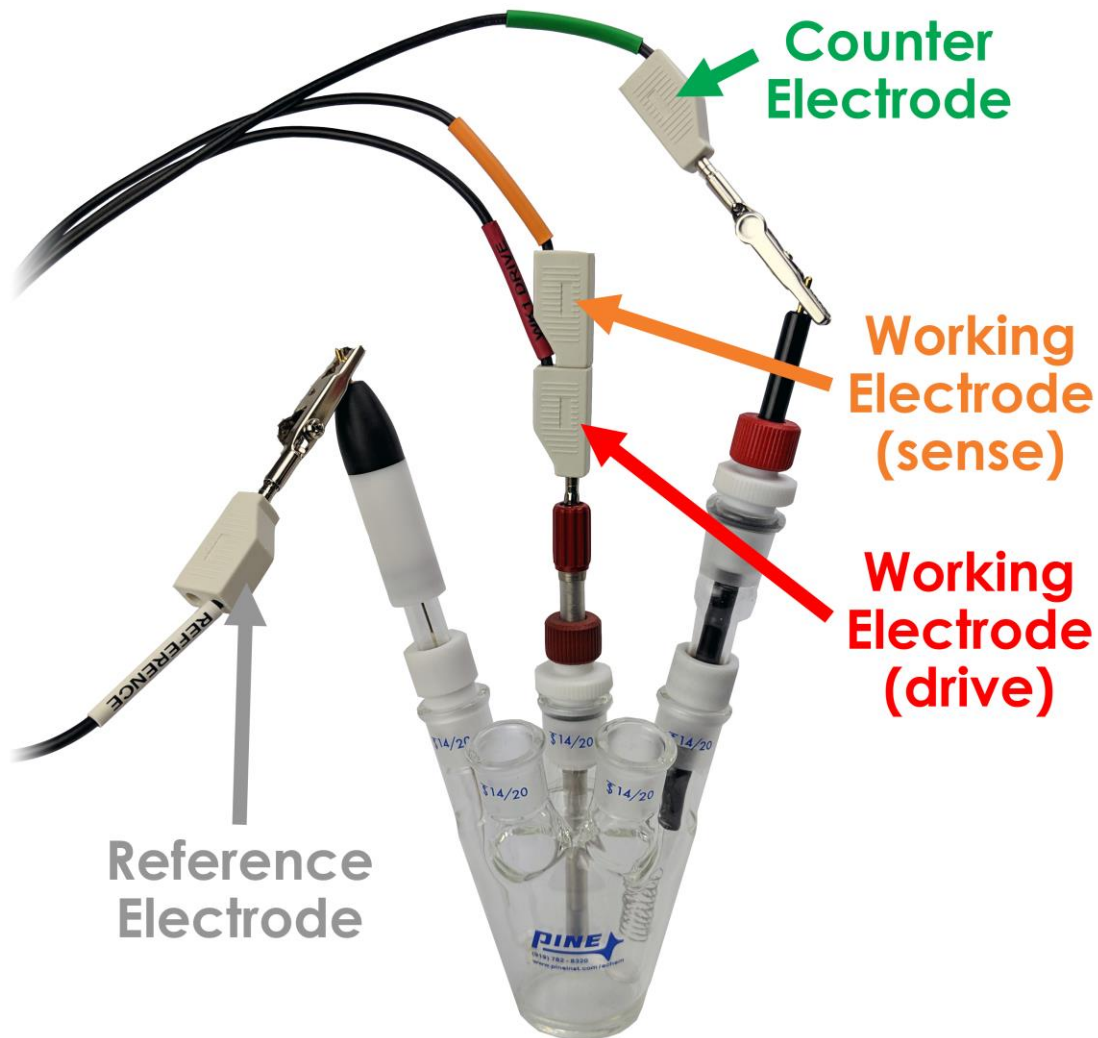

Figure 5-5. Typical Three-Electrode Cell Configuration

To drive current between the working and counter electrodes, the RED lead (K1 working electrode drive) is connected to the working electrode, and the GREEN lead (counter electrode drive) is connected to the counter electrode. To measure potential between the working and reference electrodes, the ORANGE lead (K1 working electrode sense) is also connected to the working electrode, and the WHITE lead (reference electrode sense) is connected to the reference electrode (see Figure 5-5).

Note that the three-electrode cell configuration requires both the RED and ORANGE leads (K1 working electrode drive and sense) to be connected at a point very near the working electrode. An easy way to make this connection is to stack the banana plugs for the RED and ORANGE leads together before connecting to the working electrode (see Figure 5-6). Both of these leads must be connected to the working electrode for the potentiostat to properly control the electrochemical cell.

When working with a traditional three-electrode cell, the second working electrode (K2) drive and sense lines (BLUE and VIOLET lines) are not used. These leads should be shorted together and set aside (see Figure 5-3). These lines are meant for use only with dual working electrode experiments such as those involving a rotating ring-disk electrode (see Section 5.2.4).



Figure 5-6. Working Electrode Sense and Drive Leads (K1) Shorted Together near the Electrode

5.2.3 Rotating Disk and Rotating Cylinder Electrodes (RDE and RCE)

The WaveDriver 200 may be used in conjunction with an electrode rotator to perform Rotating Disk Electrode (RDE) or Rotating Cylinder Electrode (RCE) experiments. These experiments are hydrodynamic variations of traditional three-electrode voltammetry. Rotating the working electrode (which may have a disk or cylinder geometry) at a controlled rate establishes convective mass transfer of electrolyte solution (and dissolved electroactive species) towards the electrode surface. Connecting the potentiostat to a hydrodynamic experiment involves not only making connections to the electrodes (working, counter, and reference) but also providing a rotation rate control signal to the electrode rotator.

The WaveDriver 200 Cell Cable can be used for these hydrodynamic experiments by making similar connections as those used in typical three-electrode cells (see Section 5.2.2). The GREEN lead (counter electrode drive) is connected to the counter electrode, and the WHITE lead (reference electrode sense) is connected to the reference electrode. Connections of the RED and ORANGE leads (K1 working electrode drive and sense) to the rotating working electrode are typically made via spring-loaded brush contacts that push against the shaft of the rotating electrode.

As an example of how connections are made to a rotating working electrode, consider the brush contacts on the popular Pine Research MSR Rotator system (see Figure 5-7). This rotator system features two pairs of opposing brushes on either side of the rotating shaft. The upper pair of brush contacts (RED) is used to make electrical contact with a rotating disk or cylinder electrode mounted in the rotator. The RED and ORANGE cell cable leads (K1 working electrode drive and sense) should be stacked together and connected to the upper pair of brush contacts. Note that for the Pine Research MSR Rotator, it is also common practice to use a short banana cable to connect opposing brushes (see Figure 5-7, right).

5.2.4 Rotating Ring-Disk Electrodes (RRDE)

A rotating ring-disk electrode (RRDE) cell contains a total of four electrodes – two working electrodes (disk and ring), one counter electrode, and one reference electrode. During an RRDE experiment, the WaveDriver 200 operates as a bipotentiostat, measuring the currents at the disk and ring electrodes (charge flows between the ring, the disk, and the counter electrode) while simultaneously measuring the potentials of the disk and ring electrodes with respect to the single reference electrode.

In an RRDE experiment, the counter and reference electrode connections are made in the same manner as for three-electrode cells (see Section 5.2.2). The GREEN lead (counter electrode drive) is connected to the counter electrode, and the WHITE lead (reference electrode sense) is connected to the reference electrode.

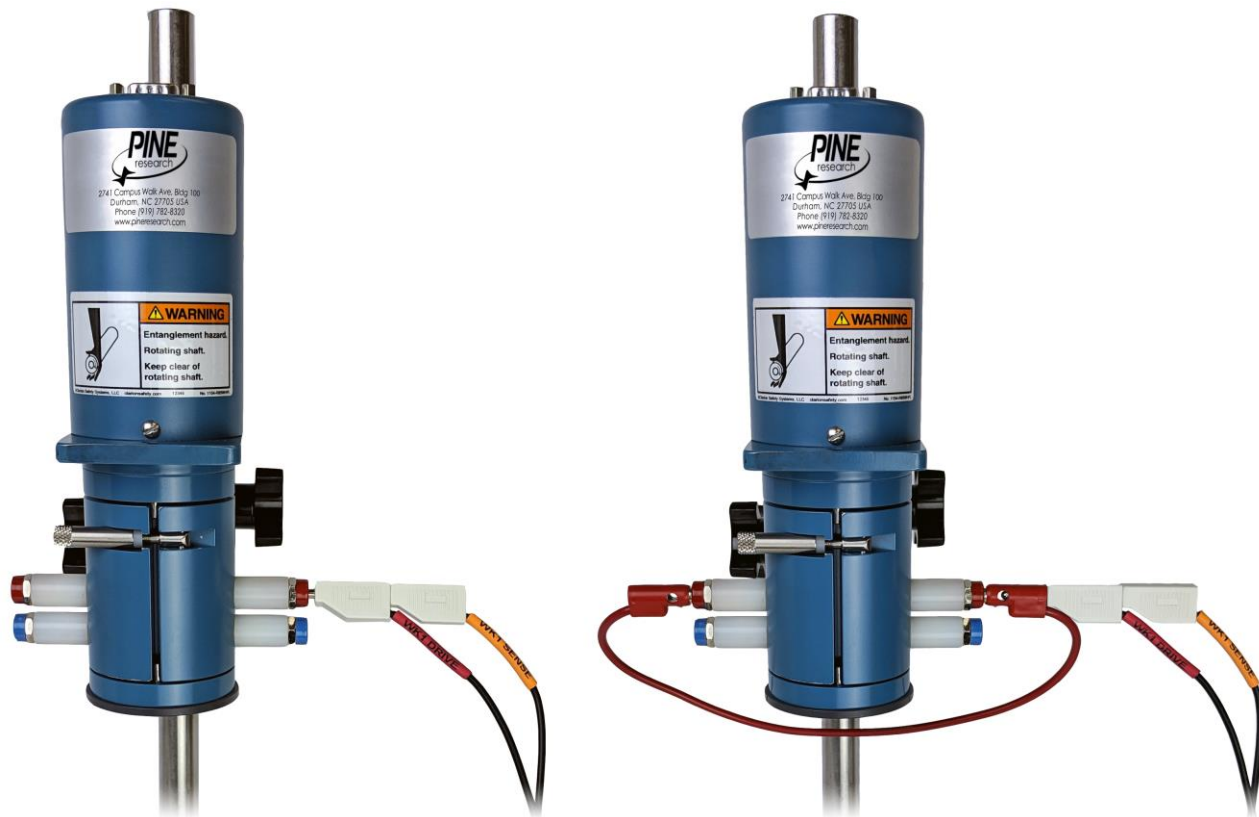

Figure 5-7. Working Electrode Connection for a Rotating Disk or Rotating Cylinder Electrode

The exact details for connecting the K1 and K2 signal lines to the disk and ring depend upon the particular electrode rotator being used. There are typically one or more brushes that contact the disk electrode and also one or more additional brushes that separately contact the ring electrode.

As an example of how to connect to an RRDE, consider the brush contacts on the Pine Research WaveVortex 10 Rotator system (see Figure 5-8). This rotator system features two brushes (one for each electrode) that are connected to banana jacks on the motor unit. The RED and ORANGE cell cable leads (K1 working electrode drive and sense) should be stacked together and connected to the disk electrode using the RED banana jack on the motor unit. The BLUE and VIOLET cell cable leads (K2 working electrode drive and sense) should be stacked together and connected to the ring electrode using the BLUE banana jack on the motor unit.

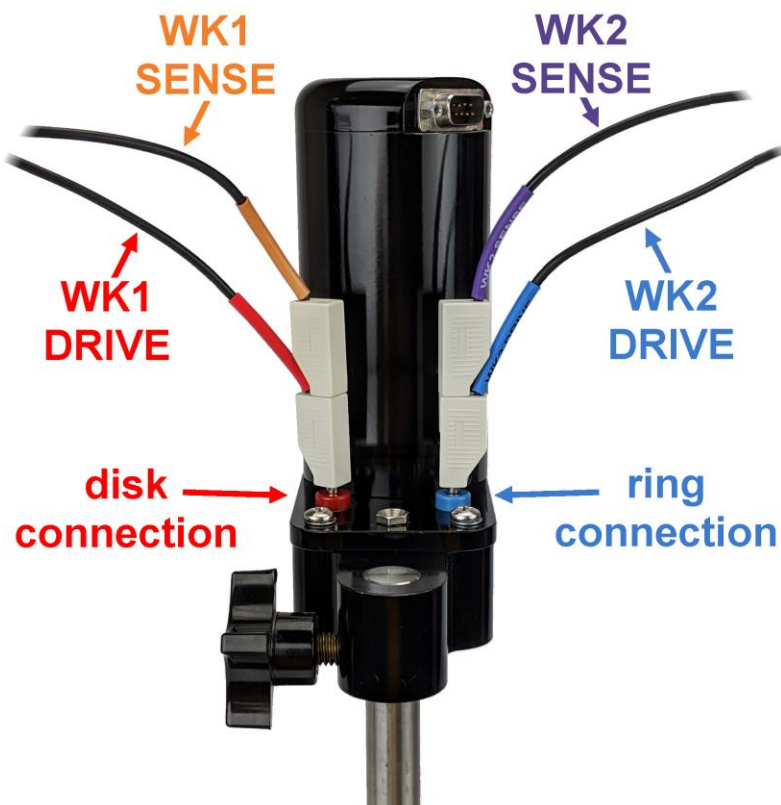

Figure 5-8. Electrode Connections for a Rotating Ring-Disk Electrode

5.2.5 Rotation Rate Control

Many electrode rotators can accept rotation rate control signals from a potentiostat. The WaveDriver 200 instrument provides both a digital “on/off” signal and an analog rotation rate signal that can be used to control the motor on an electrode rotator. These signals output from a connector on the back panel of the WaveDriver 200 (see Table 2-5). Special cables are available from Pine Research that may be used to connect these signals to various electrode rotator models.

CAUTION:

When connecting a WaveDriver 200 system to an electrode rotator other than the Pine Research MSR or WaveVortex 10 Rotator, carefully consider the magnitude of the WaveDriver 200 rate control signal ratio (1 RPM/mV) and take steps to assure that the rotator is configured to use the same ratio.



ATTENTION:

Lorsque vous connectez un appareil WaveDriver 200 à un rotateur à électrodes autre que le rotateur Pine Research MSR ou WaveVortex 10, faites très attention à la valeur du rapport du signal de contrôle de vitesse de l'appareil WaveDriver 200 (1 tr/min/mV) et assurez-vous que le rotateur soit configuré avec le même rapport.

Connecting a Pine Research WaveDriver 200 to a Pine Research MSR rotator requires a special cable (part number AKCABLE4). One end of this cable has a small green connector that fits into Control Port "B" on the back panel of the WaveDriver 200. The other end of the cable connects to the MSR control unit at two locations (see Figure 5-9). The coaxial portion of the cable connects to the pair of INPUT jacks on the front panel of the control unit. The other part of the cable terminates at a banana plug that is connected to the MOTOR STOP jack on the back panel of the control unit.



Figure 5-9. Rotation Rate Control Connections for a Pine Research MSR Rotator



Figure 5-10. Rotation Rate Control Connections for a Pine Research WaveVortex 10 Rotator

Connecting a Pine Research WaveDriver 200 to a Pine Research WaveVortex 10 rotator requires a special cable (part number AKCABLE7-03). One end of this cable has a small green connector that fits into Control Port “B” on the back panel of the WaveDriver 200. The other end of the cable terminates at a large green connector that fits into the control port on the side of the WaveVortex 10 control unit (see Figure 5-10).

5.2.6 Compact Voltammetry Cell Cable Connections

The following information details how to connect the WaveDriver 200 Cell Cable to the Pine Research Compact Voltammetry Cell Kit (available separately). This configuration involves the use of a second generic cell cable (part number RRPECBL2, available separately) that terminates with a mini-USB style plug. The other end of this cable contains four signal lines terminating in banana plugs: RED working

drive electrode, ORANGE working sense electrode, GREEN counter electrode, and WHITE reference electrode.

The Compact Voltammetry Cell Kit consists of a grip mount, cell cap, glass vial, and various screen-printed electrodes. Built into the grip mount is a mini-USB port that may be connected to the mini-USB end of the second generic cell cable. Circuitry within the grip mount makes electrical connection to the screen-printed electrode mounted in the bottom of the device (see Figure 5-11). The four banana plugs on the other end of the generic cell cable can then be connected to the corresponding colored leads on the WaveDriver 200 Cell Cable using alligator clips or by stacking them into the banana jacks on the back of each lead. This simple cable configuration makes the Compact Voltammetry Cell Kit ideal for use in educational settings and confined spaces such as gloveboxes.

It should be noted that the connection between the WaveDriver 200 Cell Cable and the generic cell cable causes a break in the shielding, meaning the driven shield from the potentiostat does not extend all the way to the mini-USB style plug. This extra connection and lack of complete shielding may result in noisy data, and the accuracy of EIS experiments in particular may be significantly affected.



Figure 5-11. Cable Connections for the Compact Voltammetry Cell Kit

6. Grounding Information

The general goal of an experiment grounding strategy is to reduce the level of signal noise in the electrochemical measurement caused by noise sources in the laboratory environment. To avoid issues with laboratory noise sources, it is important to properly ground all metal objects near an electrochemical setup and to make appropriate grounding connections between the potentiostat and any other electronic equipment used as part of the experiment.

6.1 Common Noise Sources

A modern laboratory is often full of noise sources that can interfere with the measurement of small amplitude electrochemical signals. Computers, LCD displays, video cables, network routers, network cables, ovens, hotplates, stirrers, and fluorescent lighting are all examples of common laboratory items that may electromagnetically interfere with a delicate electrochemical measurement.

The electrochemical setup, potentiostat, cell cable, and any other experimental equipment (e.g., electrode rotator) should be located as far away from noise sources as possible. It is especially important that the cell cable is located well away from any digital noise sources such as mouse or keyboard cables, network cables, video cables, USB cables, cell phones, etc. The reference electrode cable is particularly sensitive to picking up noise from the environment. Also, any piece of laboratory equipment that intermittently draws a lot of current, such as an oven or hotplate under thermostatic control, should not be powered using the same branch circuit as the potentiostat. When such a piece of equipment goes through a power cycle, it may induce noise or a glitch in the electrochemical measurement.

6.2 Grounding Terminology

A potentiostat or other piece of electronic equipment generally has three types of grounding connections that are often confused with one another: the **earth ground**, the **chassis terminal**, and the **DC Common**. These are discussed in more detail below.

6.2.1 Earth Ground



EARTH GROUND:

An earth ground connection is a direct physical and electrical connection to the Earth.

An earth ground connection is available in most modern laboratories via the third prong on the power receptacle for the local power system (see Figure 6-1). The power system infrastructure for a laboratory building usually has a long metal probe buried in the earth, and the third prong of the electrical outlets in the building wiring is connected to this earth connection. Many scientific instruments have a three-prong power cord that brings the earth ground connection to the instrument's power supply. Depending on the design of the instrument, the earth ground connection may or may not pass through the power supply to the circuitry inside the instrument.

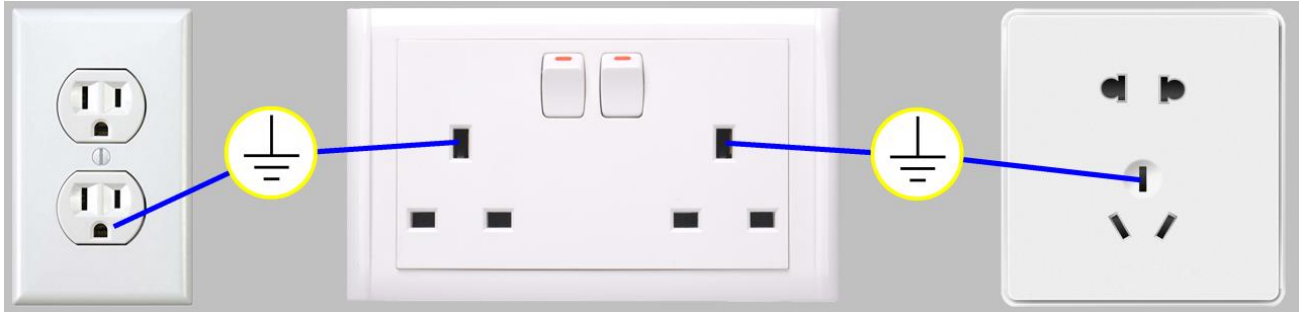

Figure 6-1. Location of Earth Ground on Common Electrical Receptacles

The power supply for the WaveDriver 200 does not allow the earth ground connection to pass through to the instrument circuitry. As a result, there is no permanent, direct connection to the earth ground when the instrument is connected to the AC Mains (there is no connection to earth ground via the power cable plugged into a receptacle).

If necessary for a given experimental arrangement, a separate and deliberate connection to earth ground can be employed. Third-party grounding kits are available that provide a convenient connection to the earth ground found on most electrical receptacles (see Figure 6-2).



Figure 6-2. A Typical Earth Ground Connection Adapter with Banana Cable

In general, a connection to earth ground need only be made if it helps to reduce (or, at least, has no effect on) the amount of noise in the electrochemical signals being measured. In some laboratory environments and for certain types of experiments (e.g., AC methods), making a connection to earth ground may actually increase the amount of signal noise. Some trial-and-error experimentation may be necessary to decide whether or not to make a connection to earth ground.

6.2.2 Chassis Terminal



CHASSIS TERMINAL:

A metal case that surrounds and protects the electronic circuitry is called a chassis. A convenient connection point to this chassis is called a chassis terminal.

The metal case that contains the WaveDriver 200 circuitry is the instrument chassis. The chassis helps to protect the circuitry from environmental noise sources and ESD events. There are two convenient access points to the instrument chassis: the GRAY banana plug on the cell cable (see Table 5-1) and the metal banana jack on the back panel (see Table 2-5).

The WaveDriver 200 cell cable has a mesh shield that is directly connected to the instrument chassis (see Table 2-3 and Section 5.1). This mesh shield effectively extends the instrument chassis along the length of the cell cable until the point where the mesh terminates and the individual cable lines emerge (see Figure 5-2).

Some experiments require that the cell cable be extended beyond its usual length. Examples include routing a long cell cable through the side of a glovebox or using the additional cable associated with the Compact Voltammetry Cell Kit (see Section 5.2.6). When the cell cable is extended beyond its normal length, the protection afforded by the mesh should also be extended whenever possible. One way to do this is to wrap the additional lengths of cable in aluminum foil and then make a deliberate connection between the foil and the instrument chassis.

When multiple measurement devices are used together in an experiment, it is common practice to connect the instrument chassis terminals for all of the instruments together. It is also common practice to place the electrochemical cell in a Faraday cage and connect the Faraday cage to the instrument chassis. These connections assure that the sensitive measurement circuitry in the various instruments and the electrochemical cell are all effectively sharing the same outer shield against environmental noise.

6.2.3 DC Common



DC COMMON:

In an analog circuit, the DC Common is the zero reference point against which signal voltages are measured. This point is also known as the analog ground, signal ground, or signal common.

The DC Common for the WaveDriver 200 is the zero volt (0.0 V) reference point used by the waveform generation and signal measurement circuits. There are two convenient access points to the DC Common: the BLACK banana jack on the back panel of the instrument and the center pin of Rotator Control Port B also located on the back panel (see Table 2-5).

The WaveDriver 200 may send or receive analog signals to and from other electronic instruments, such as a waveform generator, an x-y recorder, a digital oscilloscope, an electrode rotator, a spectrometer, or a quartz crystal microbalance. These other instruments also have a DC Common line that represents

the common “zero volt” analog signal level. In general, the act of connecting a signal cable from the WaveDriver 200 to another instrument connects the DC Common lines for both instruments.

The WaveDriver 200 offers separate connection points for DC Common and chassis terminal on the back panel (see Figure 2-2 and Table 2-5). By default, the instrument is shipped from the factory with a white shorting bar that connects the DC Common to the chassis terminal (see Figure 6-5 and Section 6.6 for further discussion). If desired, this shorting bar can be removed to allow the DC Common line to “float” with respect to the instrument chassis.

The act of deliberately floating the DC Common signal with respect to the instrument chassis may or may not reduce the amount of environmental noise picked up by the potentiostat. For any given experimental configuration, some trial-and-error experimentation may be required to determine the optimal configuration.

There are situations in which a floating DC Common is required. The most common cases are those in which one of the electrodes (usually the working or counter electrode) is part of a third-party apparatus (such as a quartz crystal microbalance or an electroplating system), and the third-party apparatus is known to make a direct connection between the electrode and the instrument chassis or earth ground. When an electrode is known to be grounded by a third-party apparatus, it is critical that all of the analog measurement signals in the WaveDriver 200 (including the DC Common) are floating with respect to the chassis and/or earth ground. Otherwise, an undesirable short circuit pathway between the electrode and DC Common is likely to occur via the third-party apparatus.

Finally, it is important to be aware of cases where a hidden connection indirectly compromises the floating DC Common. These cases can occur when multiple instruments and/or computers are interconnected with the WaveDriver 200 as part of a larger experimental configuration. One of the other instruments may make an internal connection between DC Common and the chassis or earth ground. Finding and eliminating such hidden connections often requires some detective work using an ohmmeter.

6.3 Faraday Cages

When making sensitive electrochemical measurements (e.g., electroanalytical methods employing DC currents less than one microampere ($< 1 \mu\text{A}$) or small amplitude AC methods such as Electrochemical Impedance Spectroscopy), it is very important to place the entire electrochemical cell inside a metal Faraday cage to shield the experiment from environmental noise. In addition, the portion of the cell cable (near the electrochemical cell) where the individual signal lines emerge from the protective mesh should also be placed inside the Faraday cage.

After placing the ends of the cell cable and the electrochemical cell inside of the Faraday cage, a secure electrical connection should be made between the metal Faraday cage and the WaveDriver 200 chassis terminal. This combination of the instrument chassis, the mesh around the cell cable, and the Faraday cage essentially puts the entire system (circuitry and cell) inside of an overall outer protective shield (i.e., the cell cable mesh and the Faraday cage act as an extension of the instrument chassis).

A Faraday cage can either be purchased directly from a supplier or fabricated using inexpensive and commonly-found materials. Anything from a commercial electrical enclosure to a cardboard box lined with aluminum foil can serve as a functional Faraday cage (see Figure 6-3). A Faraday cage requires an internal volume large enough to contain the entire electrochemical cell and all of the banana plugs at the end of the cell cable that connect to the various electrodes. Care should be taken to ensure that the electrode connections do not accidentally come into contact with the conductive walls of the Faraday cage.



Figure 6-3. Common Examples of Faraday Cages

6.4 Metal Apparatus

Electrochemical cells are often mounted using various metal apparatus (such as ring stands or laboratory clamps). These mounts, along with any other metal objects located near the electrochemical setup, can interfere with sensitive electrochemical measurements, especially if they are simply allowed to “float” rather than being electrically connected to a known point in the system. Some trial-and-error may be required to determine the best way to ground such metal objects, but in many cases, an alligator clip and a banana cable (see Figure 6-4) can be used to connect the metal object to the instrument chassis or to the earth ground or to both.

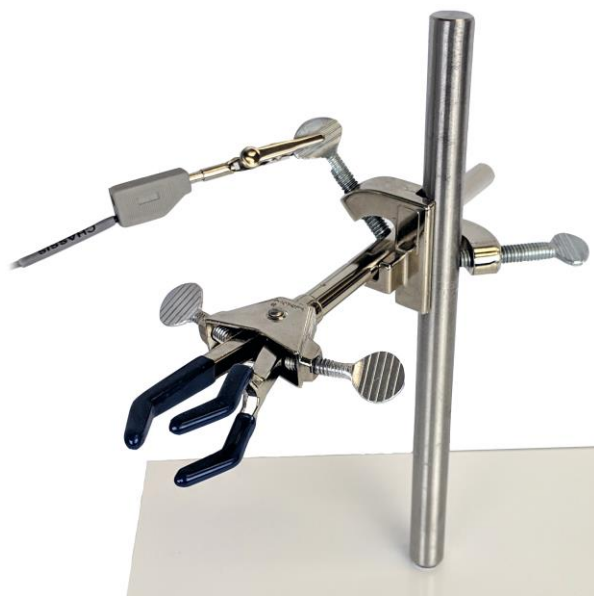

Figure 6-4. Metal Objects Near the Electrochemical Cell Should Be Grounded

6.5 USB Isolation

It is important to note that the WaveDriver 200 is designed to be connected to a personal computer (tower, desktop, or laptop) via a USB cable. It is generally undesirable for the chassis of the instrument to be connected to the chassis of the computer. To help isolate the WaveDriver 200 from the computer,

the USB port (on the back panel) is mounted in a manner that helps prevent direct shorting between the instrument chassis and the computer chassis via the USB cable. Note that the USB shield line is capacitively coupled to the chassis of the WaveDriver 200.

The communications lines within a USB cable carry digital signals and at least one line that is connected to the DC Common of the computer. To prevent interaction between the circuitry inside the computer and the sensitive measurement circuitry inside the instrument, the WaveDriver 200 has special circuitry that isolates the USB lines from the rest of the system. This prevents the DC Common of the computer from being connected to the DC Common of the instrument.

6.6 Grounding Strategies

The first step in determining the optimal grounding configuration for any electrochemical experiment is to understand the grounding configuration of the potentiostat itself. There are several possible ways in which the instrument chassis, the DC Common, and the earth ground might be connected. A summary of the most common configurations is provided (see Figure 6-5).

When the WaveDriver 200 is shipped from the factory, a white shorting bar is pre-installed on the back panel that bridges the DC Common and instrument chassis banana binding posts (see Figure 6-5A). This "DC Common-to-chassis" configuration may be suitable for some electrochemical experiments; however, in other situations it may be better to disconnect this metal shorting bar to obtain a "fully floating" condition.

In situations where it is desirable to have a "fully floating" arrangement where the DC Common floats with respect to the instrument chassis, the shorting bar may be disconnected from the DC Common and instrument chassis jacks (see Figure 6-5B). This arrangement is often required when one of the electrodes is actually part of a third-party apparatus (such as a quartz crystal microbalance or an electroplating system), and the third-party apparatus requires that the electrode be connected to the chassis or to the earth ground or to both. In these cases, the DC Common should be allowed to float with respect to the chassis to prevent an inadvertent short-circuit between the electrode and DC Common (via the third-party apparatus).

The WaveDriver 200 is designed so that no part of the instrument circuit is connected to earth ground by default. While the external power supply does have an earth ground connection, the earth ground is not passed through the power supply to the instrument. If desired, a deliberate connection between earth ground and the instrument chassis may be made. Various cables and connectors (not included) can be used to make a connection from the chassis terminal on the back panel of the instrument to the third-prong on a nearby electrical receptacle (see Figure 6-2 and Figure 6-5C).

In certain situations, it may be desired to use a "fully earth grounded" configuration (see Figure 6-5D). Similarly to the previously-described "chassis-to-earth ground" configuration, this can require various additional cables and connectors (not included). However, in many cases, connections to earth ground can introduce unknown or unwanted sources of noise in the experimental results. If the experimental setup requires that the instrument be earth grounded, then some trial-and-error may be required to determine whether or not to also connect the DC Common to earth ground.

6.7 Grounding Third-Party Instrumentation

When using one or more third-party electronic instruments together with the WaveDriver 200, a common grounding strategy is to connect the chassis of the WaveDriver 200 to the chassis of the other instrument(s). All such connections should be brought together to a single point. Any other metal

objects located near the electrochemical cell (e.g., ring stands, Faraday cage, clamps, etc.) should be connected to the same single point to avoid creating a possible grounding loop (see Figure 6-6).

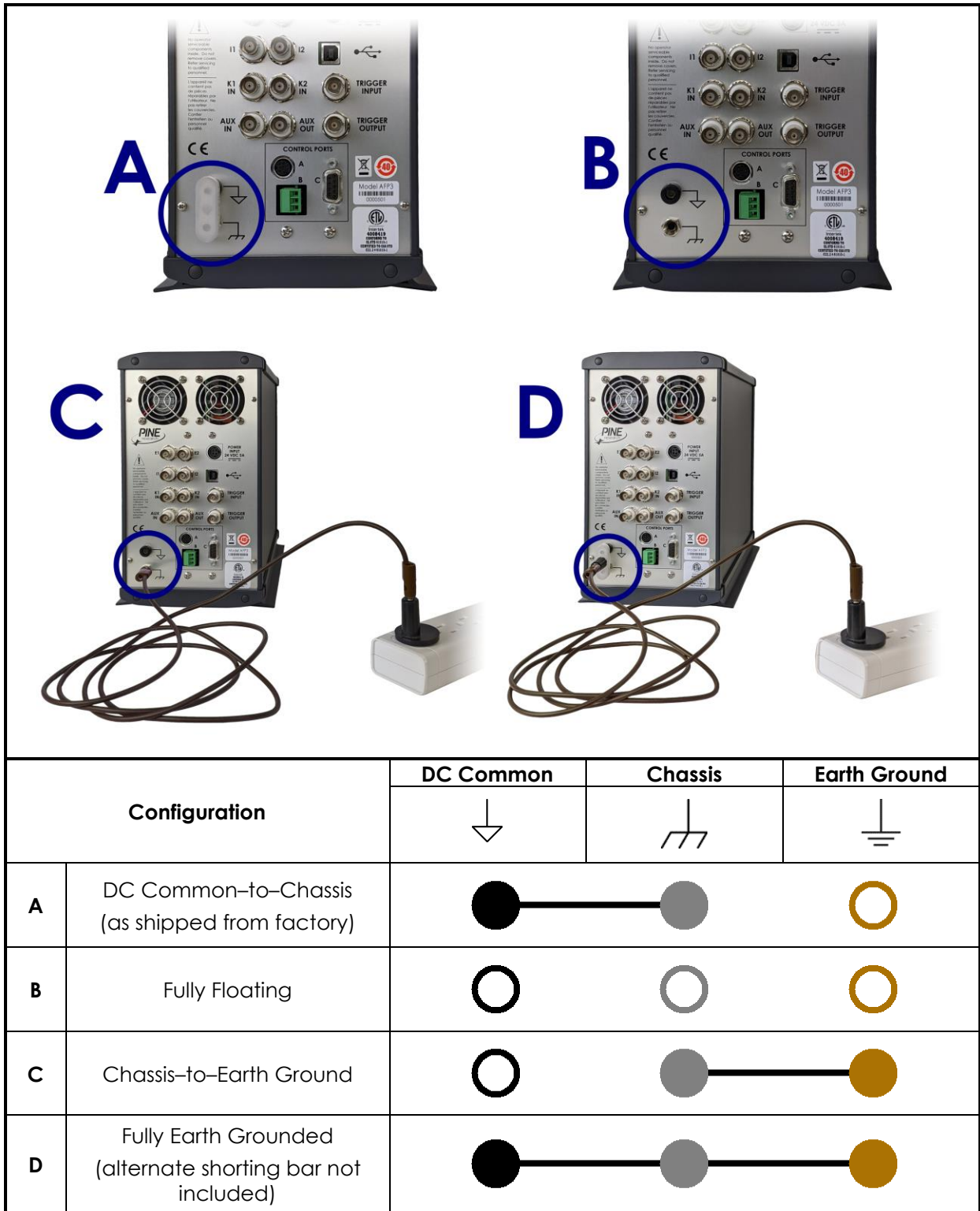

Figure 6-5. Four Common Instrument Grounding Configurations

**NOTE:**

If the WaveDriver 200 was purchased before April 2021, its back panel may be slightly different. For corresponding information on common grounding configurations, see Section 11.

When using third-party instrumentation, a decision must be made regarding whether or not to connect the chassis terminal to the earth ground. Some third-party equipment may actually force such a connection to earth ground, and sometimes this connection is hidden from view inside the third-party instrument. Trial-and-error, as well as the use of an ohmmeter, may be required to analyze and fully understand the grounding configuration when multiple instruments are used together.

Just like the WaveDriver 200, third-party instruments also have their own DC Common line that represents the common “zero volt” analog signal level within the third-party instrument’s circuit. When the WaveDriver 200 is connected to an electrode rotator control unit, a spectrometer, a quartz crystal microbalance, or other third-party instrument, a connection is almost always made between the DC Common lines of the various instruments. In these cases, it is important to be aware of whether or not the DC Common of a third-party instrument happens to also be connected to earth ground or to the instrument chassis. Such connections are sometimes hidden within the third-party instrument. Again, some trial-and-error, as well as the use of an ohmmeter, may be required to confirm whether or not the DC Common is floating with respect to the chassis (or with respect to earth ground).



Figure 6-6. Connect All Instrument Chassis Terminals to a Common Point





**NOTE:**





A grounding loop is often accidentally created when ground connections are made in series from one instrument to the next. The resulting loop can act as a large antenna that injects environmental noise into sensitive signal measurements.

To prevent accidental creation of a grounding loop, bring all grounding connections together to a common point.

7. Power Cords

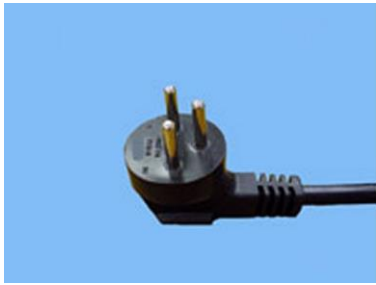
The standard C14 connector on the WaveDriver 200 power supply is compatible with a wide range of power cords available from Pine Research. Each of the available power cords is rated at 10 A (minimum), and each cord is designed for use in a specific country or region of the world. Representative images and Pine Research part numbers are provided below (see Table 7-1).

Image	Description	Part Number	Notes
	Power Cord (USA)	EWM18B7	This cord is for use in the USA, Canada, Mexico, Brazil, Colombia, Saudi Arabia, and Taiwan
	Power Cord (Europe)	EWM18B8EU	This cord is for use in continental Europe, Korea, Russia, and Indonesia
	Power Cord (UK)	EWM18B8UK	This cord is for use in the United Kingdom, Ireland, Kuwait, Malaysia, Oman, Hong Kong, and Singapore
	Power Cord (China)	EWM18B8CN	This cord is for use exclusively in China

	<p>Power Cord (South Africa)</p>	<p>EWM18B8SA</p>	<p>This cord is for use in South Africa</p>
	<p>Power Cord (Israel)</p>	<p>EWM18B8IL</p>	<p>This cord is for use exclusively in Israel</p>
	<p>Power Cord (Japan)</p>	<p>EWM18B8JP</p>	<p>This cord is for use exclusively in Japan</p>
	<p>Power Cord (South Korea)</p>	<p>EWM18B8KR</p>	<p>This cord is for use exclusively in South Korea</p>
	<p>Power Cord (Argentina)</p>	<p>EWM18B8AR</p>	<p>This cord is for use exclusively in Argentina</p>





	<p>Power Cord (Denmark)</p>	<p>EWM18B8DK</p>	<p>This cord is for use exclusively in Denmark</p>
	<p>Power Cord (Australia)</p>	<p>EWM18B8NZ</p>	<p>This cord is for use in Australia and New Zealand</p>
	<p>Power Cord (Switzerland)</p>	<p>EWM18B8CH</p>	<p>This cord is for use exclusively in Switzerland</p>
	<p>Power Cord (Italy)</p>	<p>EWM18B8IT</p>	<p>This cord is for use exclusively in Italy</p>

Table 7-1. Select Power Cords Available from Pine Research

8. Theory

A cursory introduction to theory and concepts related to electrochemical impedance spectroscopy is presented herein. For a more thorough and complete study, the reader is encouraged to consult academic textbooks and the scientific literature¹⁻²³. A survey of references on this topic is provided in Section 8.2.

8.1 Electrochemical Impedance Spectroscopy

Experimental electrochemistry can be as powerful as it is tricky. Even simple DC methods (e.g., voltammetry, open circuit potential, chronoamperometry, chronopotentiometry) are often plagued by inaccuracies and/or poor signal-to-noise ratios resulting from seemingly insignificant or overlooked sources. Variables that can affect electrochemical data include, but are not limited to: the state and quality of electrodes, electrolyte, experimental hardware, the physical laboratory layout, software experimental parameters, arrangement of cables, and grounding configuration (see Section 6 for details on grounding).

AC techniques, like electrochemical impedance spectroscopy (EIS), can be similarly affected by these variables and sources of error. The user must exercise particular care and caution when setting up and running EIS experiments as the impact of small sources of error often has a larger effect on data quality than for DC methods. Obtaining and interpreting meaningful EIS data, as with many other facets of electrochemistry, requires repeated practice and often some trial-and-error with respect to both the hardware and software.

8.1.1 Basic Background Theory

In AC electrochemistry, a sinusoidal potential (or current) signal is applied to a system and the resulting current (or potential) signal is recorded and analyzed (see Figure 8-1 for diagram and associated terminology). The frequency and amplitude of the input signal are tuned by the user, while the output signal normally has the same frequency as the input signal but its phase may be shifted by a finite amount.

Practically, frequency (f) is reported in units of Hz. However, for mathematical convenience the angular frequency (ω), which has units of rad/s and is equivalent to $2\pi f$, is typically used for calculations instead (e.g., see input and output signal equations in Figure 8-1). Similarly, the phase angle (ϕ) is typically reported in units of degrees but calculated in units of radians.

There are three conventions often used to define the input (and sometimes output) signal amplitude: peak, peak-to-peak, and RMS. "Peak" refers to the difference between the sine wave set point (i.e., the potential or current at the beginning of the sine wave period) and its maximum or minimum point (i.e., the potential or current at one quarter of the sine wave period). "Peak-to-peak" is simply twice the peak value (see Figure 8-1).

"RMS", which stands for "root mean square", is a mathematical quantity used primarily in electrical engineering to compare AC and DC voltages or currents. Though its practical relevance and importance to EIS measurements is somewhat minimal, it is still widely used in the industry to characterize input signal amplitude. Mathematically, it is equivalent to the peak value divided by $\sqrt{2}$, or roughly peak times 0.707 (see Figure 8-1).

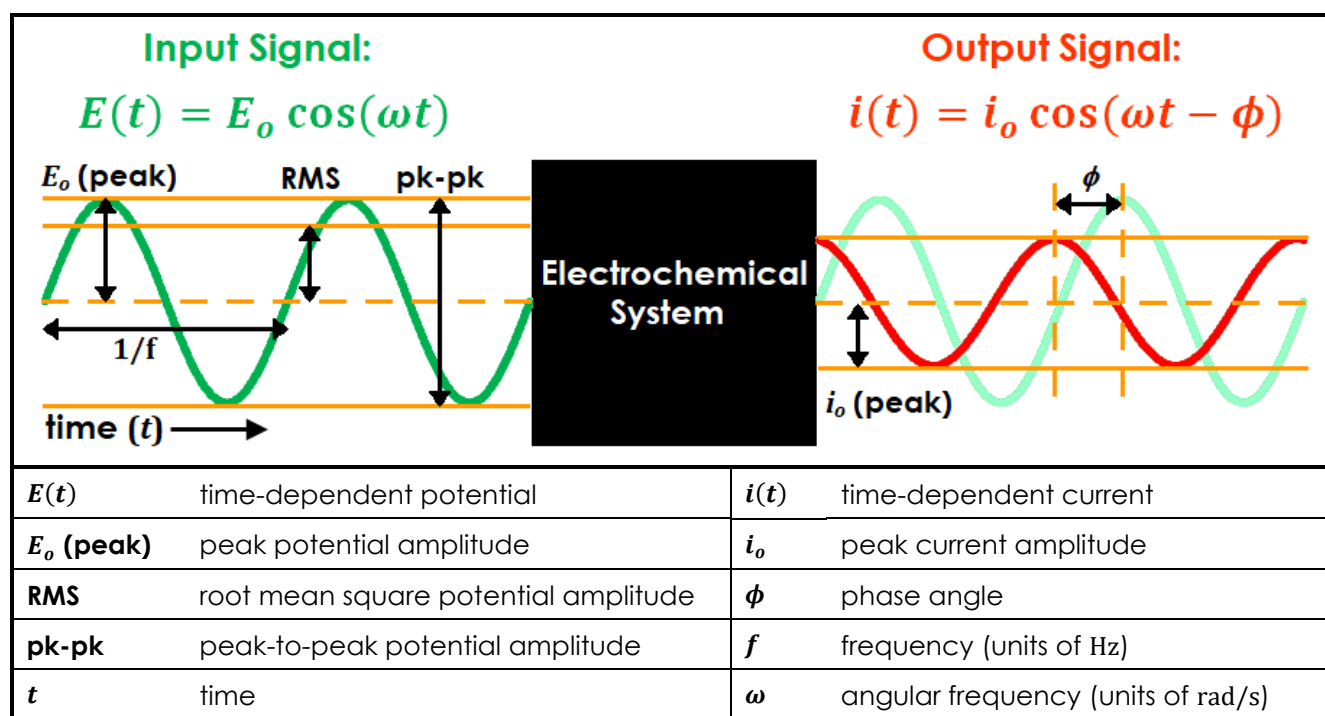

Figure 8-1. AC Electrochemistry Sine Wave Input and Output Terminology

During an EIS experiment, a sequence of sinusoidal potential signals with varying frequencies, but similar amplitudes, is applied to an electrochemical system. Typically, frequencies of each input signal are equally spaced on a descending logarithmic scale from ~ 10 kHz – 1 MHz to a lower limit of ~ 10 mHz – 1 Hz. Application of these input and output signals is usually performed automatically via a potentiostat/galvanostat.

Monitoring the progress of an EIS experiment can be done by observing the input and output signals on a single current vs. potential graph called a Lissajous plot (see Figure 8-2). Depending on the system under study, as well as the applied frequency and amplitude, the shape of the resulting Lissajous plot may vary. Throughout an EIS experiment, the user can observe the progression and pattern of Lissajous plots as a means of identifying possibly erroneous data.

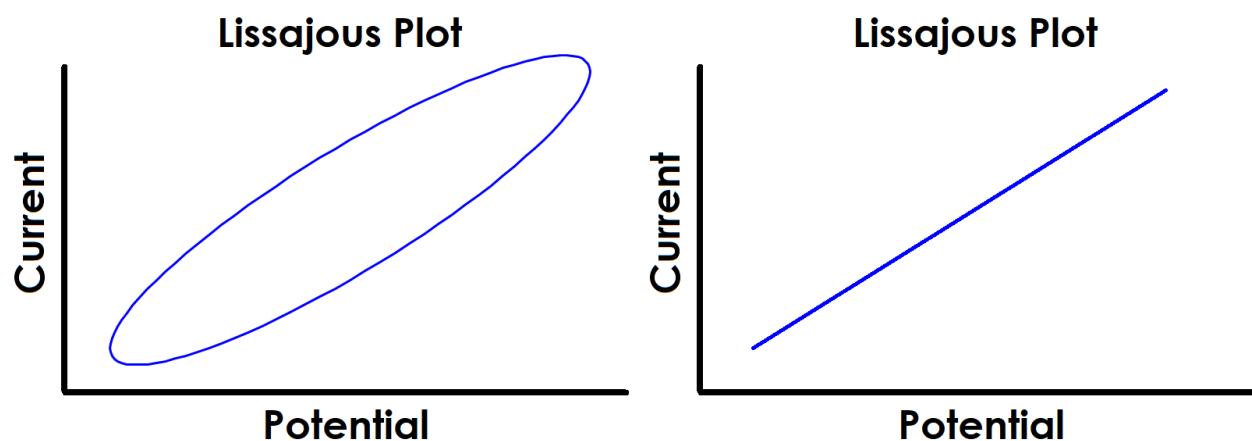

Figure 8-2. Examples of Typical Lissajous Plots for Stable and Linear Systems

The shape of the current vs. potential Lissajous plot for a stable, linear electrochemical system typically appears as either a tilted oval or straight line that repeatedly traces over itself (see Figure 8-2). The width of the oval is indicative of the magnitude of the output signal phase angle. For example, if the Lissajous plot looks like a perfect circle, it means the output signal is completely out of phase (*i.e.*, $\pm 90^\circ$) with respect to the input signal. This is also the EIS response experienced by an ideal capacitor or inductor.

8.1.2 Mathematical Theory

Impedance is defined as the measure of difficulty a circuit experiences related to the passage of an applied alternating electrical current. It is analogous to Ohm's law (see Equation 1 in Section 4.2.7), but unlike Ohm's law impedance can change as a function of the frequency of the applied potential or current.

During an EIS experiment, if the applied signal is potential and the measured result is current, it is referred to as "potentiostatic EIS". When the applied signal is current and the measured result is potential, it is referred to as "galvanostatic EIS". For the case of potentiostatic EIS as shown in Figure 8-1, a potential is applied with the form

$$E(t) = E_0 \cos(\omega t) \quad (3)$$

where E_0 is the potential sine wave amplitude, ω is the angular frequency, t is the time, and the term ωt represents the phase of the waveform. If E_0 is small enough such that the system is linear (see Section 8.1.4 for conditions of impedance validity), the resultant current waveform is also sinusoidal and will have the same frequency as the input signal; however, it may be shifted in phase, as shown graphically in Figure 8-1 and mathematically below:

$$i(t) = i_0 \cos(\omega t - \phi) \quad (4)$$

where i_0 is the current sine wave amplitude and ϕ is the phase angle shift.

A more convenient mathematical rearrangement of the applied and resultant waveforms (Equations 3 and 4) is needed to clarify the measured impedance. This is accomplished by using complex coordinates via Euler's formula, which is defined as

$$e^{jx} = \cos x + j \sin x \quad (5)$$

where j represents the imaginary unit (rather than the conventional symbol, i , to prevent confusion with the symbol for current) and x is any real number. If x is substituted by an angle with the form $\omega t + \phi_n$ similarly to Equations 3 and 4, where ϕ_n is any given phase angle shift, and all terms are multiplied by a given constant amplitude, A_n , Equation 5 is rearranged as follows:

$$A_n \cos(\omega t + \phi_n) = A_n e^{j(\omega t + \phi_n)} - j A_n \sin(\omega t + \phi_n) \quad (6)$$

The right-hand side of Equation 6 is a complex number while the left-hand side contains only a real quantity. Therefore, by equating the real portions of both sides of the equation, the following expression is obtained:

$$\text{Re}\{A_n \cos(\omega t + \phi_n)\} = \text{Re}\{A_n e^{j(\omega t + \phi_n)} - j A_n \sin(\omega t + \phi_n)\} \quad (7)$$

where Re is the real portion of a number. The second term on the right-hand side of Equation 7 is eliminated because it is entirely imaginary, and the Re operator is removed from the left-hand side because the cosine of a real number is also a real number:

$$A_n \cos(\omega t + \phi_n) = \text{Re}\{A_n e^{j(\omega t + \phi_n)}\} \quad (8)$$

Equation 8 is further simplified as follows:

$$A_n \cos(\omega t + \phi_n) = \text{Re}\{\tilde{X} e^{j\omega t}\} \quad (9)$$

where \tilde{X} is a collection of all time-invariant terms and is equivalent to

$$\tilde{X} = A_n e^{j\phi_n} \quad (10)$$

Using Equation 9, the applied potential and resultant current waveforms shown in Equations 3 and 4, respectively, are rewritten as

$$E(t) = \text{Re}\{\tilde{E} e^{j\omega t}\} \quad (11)$$

$$i(t) = \text{Re}\{\tilde{i} e^{j\omega t}\} \quad (12)$$

where the time-invariant terms \tilde{E} and \tilde{i} are equivalent to

$$\tilde{E} = E_0 \quad (13)$$

$$\tilde{i} = i_0 e^{-j\phi} \quad (14)$$

One condition of validity for impedance is stability (i.e., steady-state or time-invariant – see Section 8.1.4). Therefore, following Equations 11 through 14, an expression for impedance, Z , analogous to Ohm's law is shown below:

$$Z = \frac{\tilde{E}}{\tilde{i}} \quad (15)$$

Substituting Equations 13 and 14 into Equation 15 yields the expression

$$Z = |Z| e^{j\phi} \quad (16)$$

where $|Z|$ is the impedance magnitude and is equivalent to $\frac{E_0}{i_0}$. Using Euler's formula (Equation 5), Equation 16 is finally expanded to the form

$$Z = |Z|(\cos \phi + j \sin \phi) = Z_r + jZ_i \quad (17)$$

This mathematical rearrangement allows the real (Z_r , equivalent to $|Z| \cos \phi$) and imaginary (Z_i , equivalent to $|Z| \sin \phi$) components of the impedance to be calculated separately.

During an EIS experiment, most commercial software packages automatically perform Fourier transform on the input and output signals at each frequency to extract corresponding values for $|Z|$ and ϕ . These values are then used with Equation 17 to calculate Z_r and Z_i . Hence, the result from a typical EIS experiment is a data table with five columns: f , Z_r , Z_i , $|Z|$, and ϕ .

8.1.3 EIS Data Plotting

There are two standard types of plots generated from five-column EIS data: Nyquist and Bode plots. A Nyquist plot normally consists of $-Z_i$ vs. Z_r , and this type of plot is most commonly used to identify distinctive patterns and shapes in the data (see Figure 8-3 for examples of Nyquist plots for several different circuit networks).

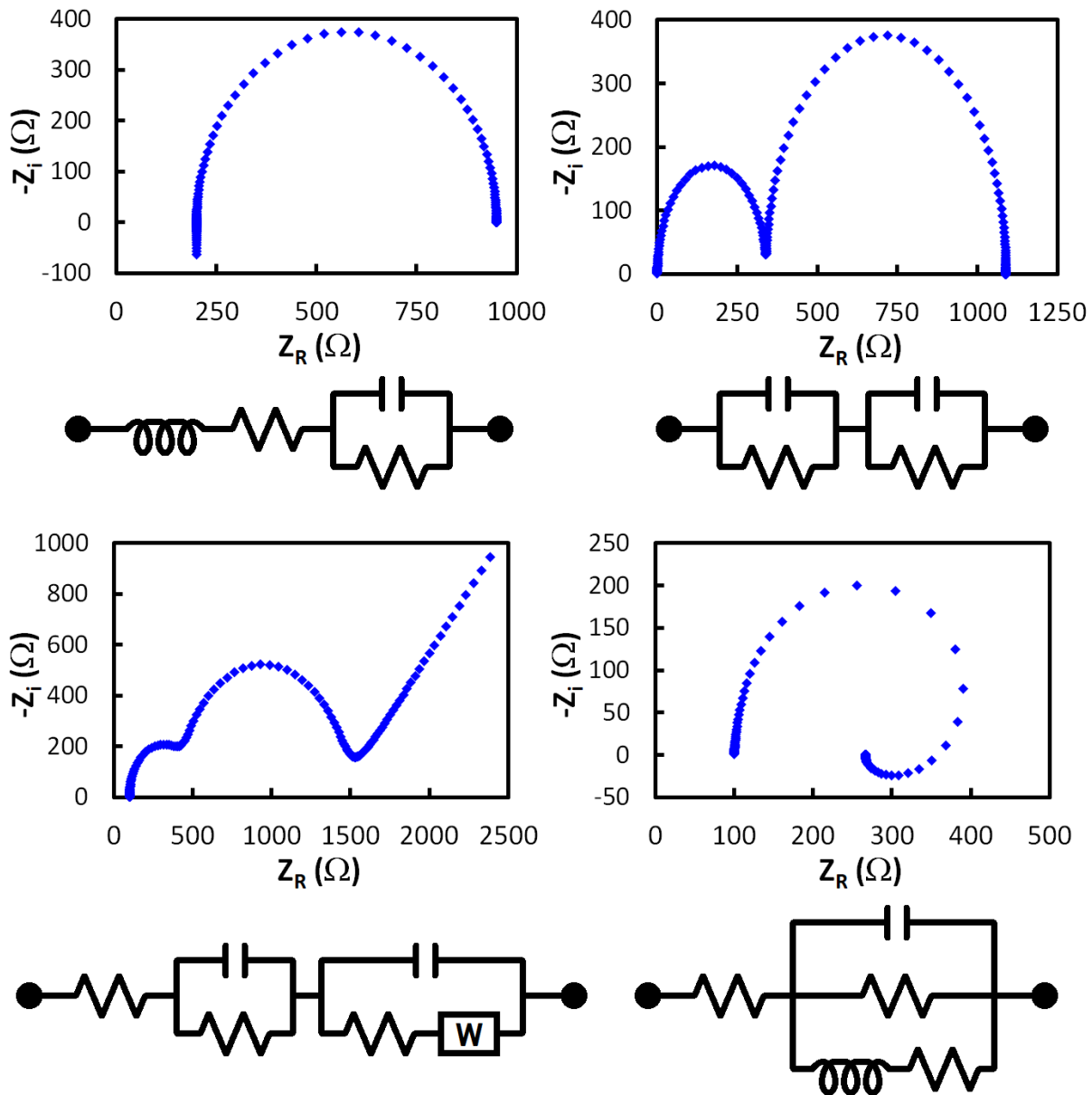

Figure 8-3. Example Nyquist Plots for Different Circuit Networks

The imaginary impedance values on a Nyquist plot are commonly inverted, or conversely the Z_i axis is sometimes displayed in reverse numerical order, due to the fact that almost all Z_i values are normally less than zero and it is more convenient to view shapes and patterns primarily in the first quadrant on a Cartesian graph (see Figure 8-3).

Another convention traditionally applied to Nyquist plots is orthonormality, which refers to the usage of a 1:1 ratio for the scale of x- and y-axes. Historically, this was used exclusively on Nyquist plots because some of the ubiquitous shapes (e.g., semicircles and tilted lines) are more easily discerned when viewed on an orthonormal plot. Many EIS users still hold to this convention; however, much of its necessity has become diminished with the advent of circuit fitting software. While non-idealities in data can be observed through distorted semicircles and tilted line angles on an orthonormal Nyquist plot, they are also easily visualized and more conveniently quantified via circuit fitting algorithms. It can also be somewhat inconvenient to force orthonormality on some Nyquist plots as quite often the data becomes concentrated to a small portion of the plot, leaving large swaths of empty graphical space.

The second standard type of plot used with EIS data is a Bode plot. A Bode plot is a double-axis plot consisting of both $|Z|$ vs. f (on the primary vertical axis) and ϕ vs. f (on the secondary vertical axis). Frequency and impedance magnitude are normally plotted on a logarithmic scale, while the phase angle is displayed linearly (see Figure 8-4 for examples of Bode plots for several different circuit networks).

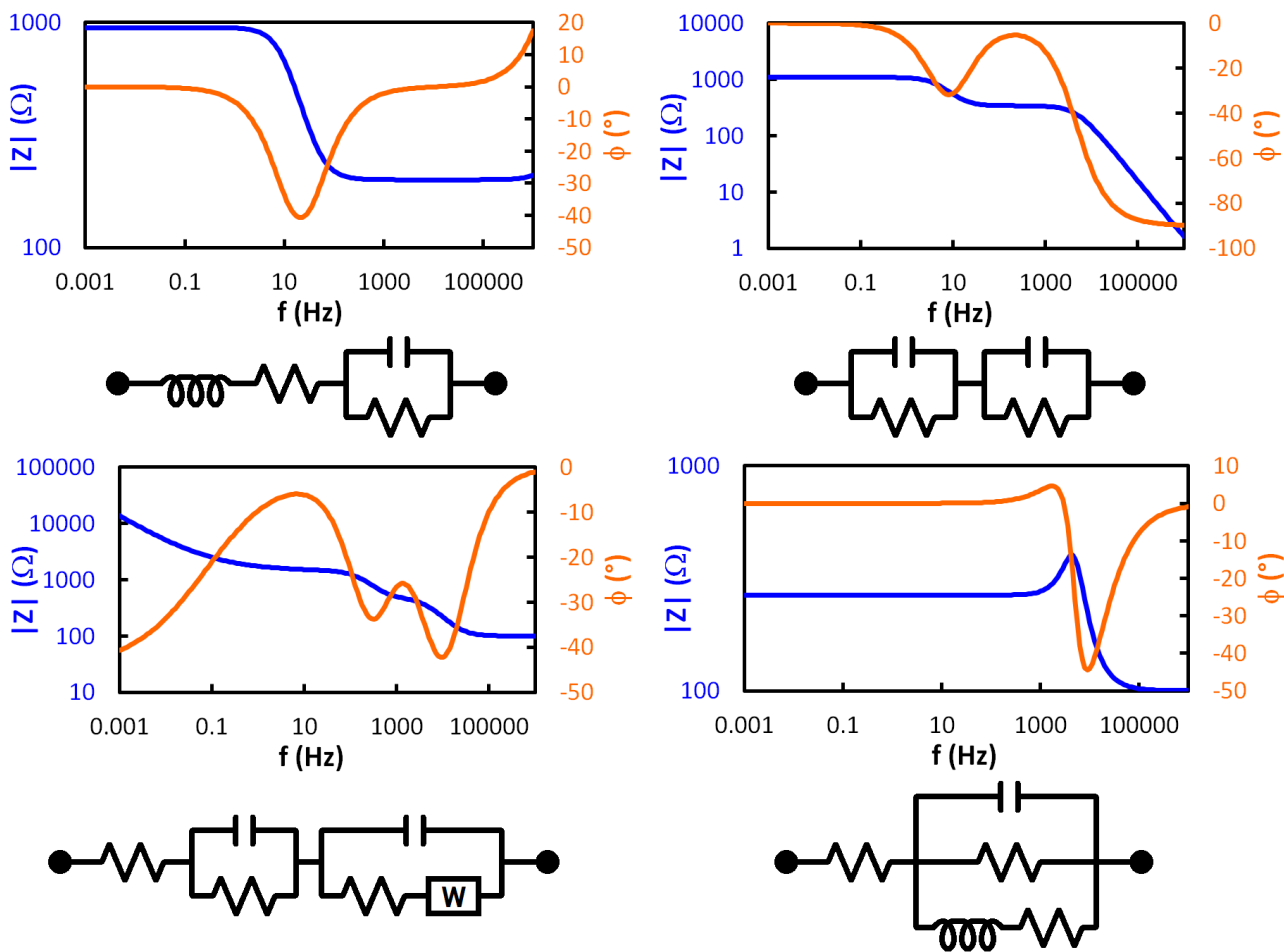

Figure 8-4. Example Bode Plots for Different Circuit Networks

Observing the phase angle on a Bode plot is a quick way to understand the type of circuit behavior a system is experiencing at any particular frequency. For example, a phase angle of 0° corresponds to an ideal resistor, 90° corresponds to an ideal inductor, and -90° corresponds to an ideal capacitor. Values in between may indicate mixed behavior or non-ideality depending on the system under study.

Bode plots also allow easy determination of frequency values, compared with Nyquist plots where frequency values are not plotted. Generally, the lower-leftmost points on a Nyquist plot correspond to the highest frequencies, and following the trace to the right moves from high to low frequency.

8.1.4 Data Accuracy and Validity

Prior to analysis of EIS data, it is critical to consider how potentiostat limits may affect the accuracy of results. All commercial potentiostats have calibrated internal hardware (and often external hardware, like the cell cable, as well), but there are always physical limitations on the range of conditions an instrument can accurately measure. The user should consult the potentiostat's accuracy contour plot (ACP), which is a half-Bode plot illustrating the accuracy limits of measured $|Z|$ over a wide range of frequencies (see Section 2.3.2 and Figure 2-1), to evaluate data accuracy, particularly at high frequencies where the accuracy becomes substantially reduced.

In addition to the physical limitations of the potentiostat being used to collect EIS data, there are other factors to consider related to data accuracy and validity. While an AC signal (potential or current waveform) can be physically applied to almost any electrochemical system, it is not guaranteed that the resulting data may be accurately classified as "impedance". There are three primary conditions that must be met during an EIS experiment for the results to be considered valid impedance data:

- **Stability** – the electrochemical system must not change with respect to time, and it must return to its initial state without further oscillations once the applied signal is terminated
- **Causality** – the resultant signal must only be caused by, and be solely a function of, the applied signal
- **Linearity** – the resultant signal must exhibit a linear response to the applied signal; or, the resultant signal must obey the law of superposition with respect to the input signal; or, the measured impedance of the resultant signal must be independent of the magnitude of the applied signal amplitude

One strategy for maintaining stability is to allow sufficient settling time at the EIS setpoint before applied sinusoidal signals begin. Enough time must be allowed for the system to reach steady-state before collecting EIS data, otherwise there may be drift in the baseline that leads to unsteady and erroneous EIS data. Effect of drift is also more pronounced at lower frequencies due to the extended time required to complete slower sine waves (see Figure 8-5 for effect of drift on sinusoidal signals and Lissajous plots).

Often, the EIS setpoint is chosen as the open circuit potential. In these cases, the system may not need much extra time to reach a stable condition since it may already be at open circuit during idle periods before running the EIS experiment. When applying sinusoidal signals on top of a potential or current setpoint, however, lack of sufficient settling time can lead to erroneous data. Additionally, since most commercial potentiostats automatically perform an OCP measurement during EIS experiments, switching between setpoint and OCP just prior to applied sinusoidal signals may interrupt the stability of an electrochemical system. When possible, a final settling period placed between the OCP step and applied sinusoidal signals should be added to prevent baseline drift.

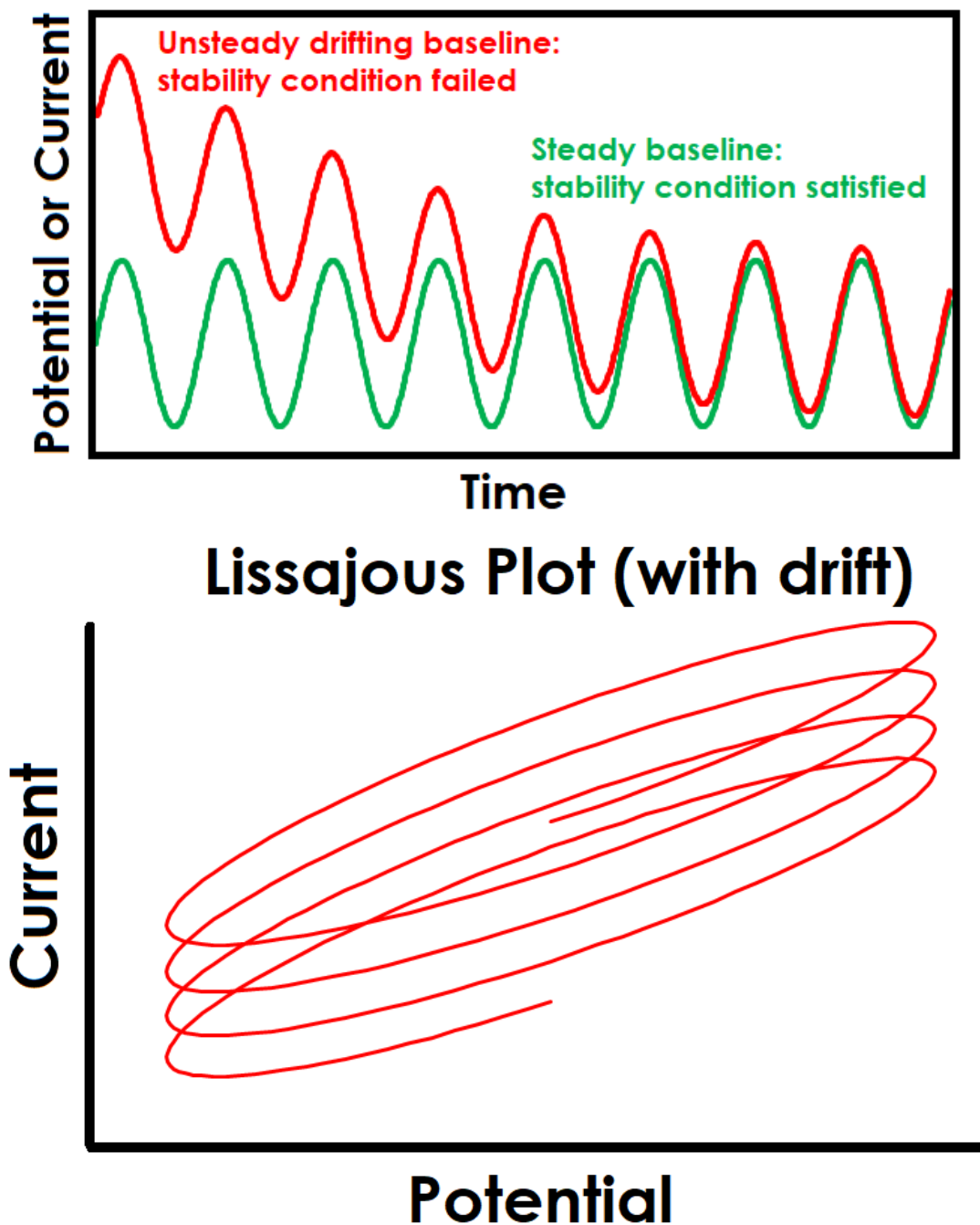

Figure 8-5. Drifting Baseline Effect on Sinusoidal Signal and Lissajous Plot

Causality is a difficult condition to determine practically. It can be tricky to know definitively whether the electrochemical response during an EIS experiment is solely a result of the applied signal. One way to indirectly infer causality is to observe the system response, if any, once the applied sinusoidal signals have completed (see Figure 8-6 for examples of both potentially causal and non-causal cases). While it is not absolute evidence of a lack of causality, observing continued noise or oscillations after the signal has been discontinued may cast doubt on whether the electrochemical signal was influenced by other sources or general system instability.

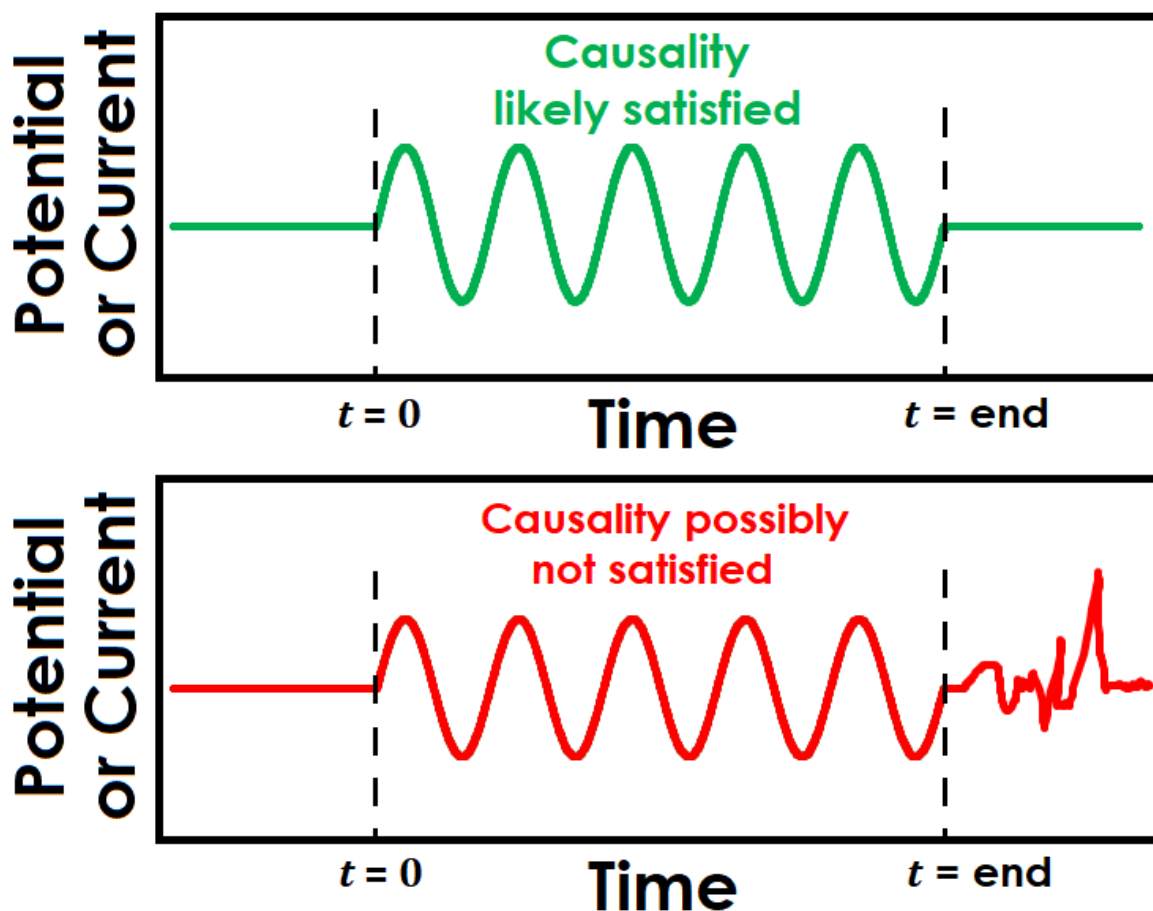

Figure 8-6. Illustration of EIS Causality Condition

The condition of linearity is often satisfied by taking precautions with respect to the amplitude of an EIS experiment. For example, even though the average electrochemical system is entirely nonlinear, it may be considered roughly linear over a narrow potential window. It is therefore commonplace for the applied signal amplitude to be very small (around 5 – 20 mV for potentiostatic EIS) to ensure linearity. However, it is also important that the applied signal is large enough to properly induce a measurable response for the potentiostat to monitor. This creates a balancing act to find the optimal range of applied signal amplitudes: large enough to adequately excite the system but small enough to maintain linearity. Typically, trial-and-error is the most effective way to clarify this range and determine the desirable experimental parameters for a given electrochemical system.

As this optimal amplitude is elucidated during experimentation of EIS parameters, another check on linearity can be done by observing the ratio of input and output amplitudes (E_o and i_o – see Figure 8-1). For example, if the input amplitude is doubled and the output amplitude does not also double, the linearity condition is not likely satisfied.

Finally, perhaps the most obvious indication of a lack of linearity can be quickly determined by the shape of the Lissajous plot. Figure 8-2 shows examples of Lissajous plots for linear systems, and examples of distorted Lissajous plots from nonlinear systems are shown in Figure 8-7. Some commercial software packages display Lissajous plots as they occur live during an EIS experiment. In these cases, the user can rapidly determine if the system is displaying nonlinear behavior and cancel the test if necessary.

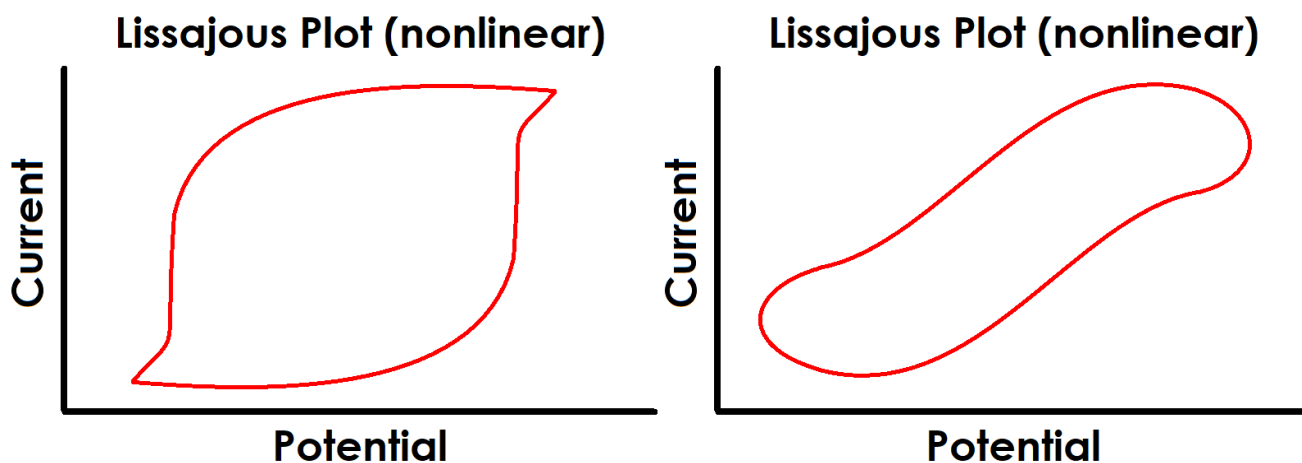

Figure 8-7. Examples of Possible Lissajous Plots for Nonlinear Systems

8.1.5 Kramers-Kronig

In addition to the previously-described methods to determine the extent of linearity, causality, and stability during an EIS experiment, investigation into these conditions of validity can be more easily performed on the data after completing the experiment. This is accomplished using the Kramers-Kronig transforms, which are mathematical relations for the real and imaginary components of a complex system that define it as linear, causal, stable, and finite¹⁸⁻²³. If any given set of EIS data can be fitted using these expressions, it may generally be assumed that the data is valid impedance.

Strict mathematical application of the Kramers-Kronig transforms is practically impossible for real EIS data because they require integration between limits of zero and infinite frequency, which are not physically possible to measure. A separate technique, developed by Boukamp²³, is instead typically used, where the experimental data is fitted using a representative circuit (see Figure 8-8). This circuit itself passes the Kramers-Kronig test; therefore, any real data that can be successfully fitted to it must also pass and therefore be considered valid impedance data.

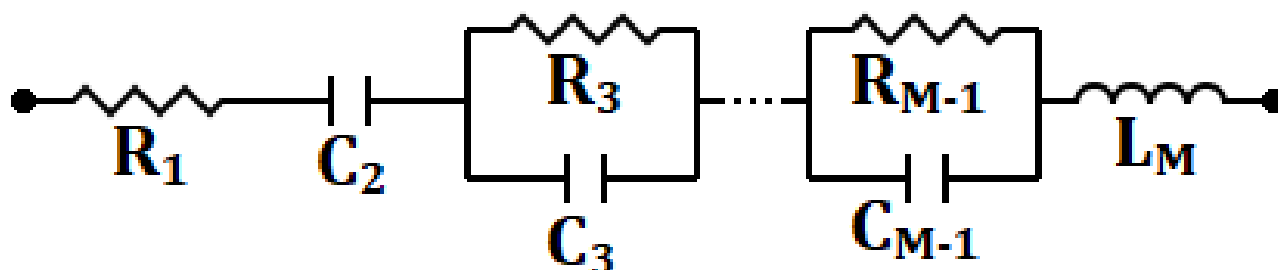

Figure 8-8. Representative Circuit Used in Kramers-Kronig Fitting

The Kramers-Kronig representative circuit (see Figure 8-8) contains an indeterminate number of Voigt elements (resistor-capacitor-in-parallel). The optimal number of these circuit elements varies depending on a few factors, including the number of data points and decades of frequency. It can therefore be tricky for the user to intuitively know the precise number of elements to select. Too few or too many Voigt elements can lead to either an under-constrained or over-constrained condition, which then may produce a false negative result. It is critical that the user know whether a poor Kramers-Kronig fit is the result of improper circuit design or impedance data that truly does not meet the conditions of validity.

For this reason, AfterMath software automatically performs an algorithm on every Kramers-Kronig fit, without requiring user input, to determine the optimal number of circuit elements so that the result may be trusted.

An example EIS validity test using Kramers-Kronig analysis in AfterMath is shown below (see Figure 8-9) for EIS data collected using the Pine Research Universal Dummy Cell "EIS" circuit (see Section 4.7 for more details). The upper pair of plots (Bode and Nyquist) show excellent correlation between experimental results (individual point markers) and the Kramers-Kronig fit (solid lines), with a χ^2 error statistic of only 0.0004675. The lower pair of plots (Bode and Nyquist) were generated by cascading a baseline drift over the duration of all frequencies (similarly to the top, red curve shown in Figure 8-5), and calculating the effect on resulting EIS data. Since the EIS experiment is conducted from high to low frequency, the greatest impact is observed at low frequencies because the baseline drift is on a similar time scale as the period of sine wave being applied. A deviation between experimental data and Kramers-Kronig fit, as well as a χ^2 error statistic more than two orders of magnitude higher than the data with no drift, suggests the baseline drift data is not valid impedance.

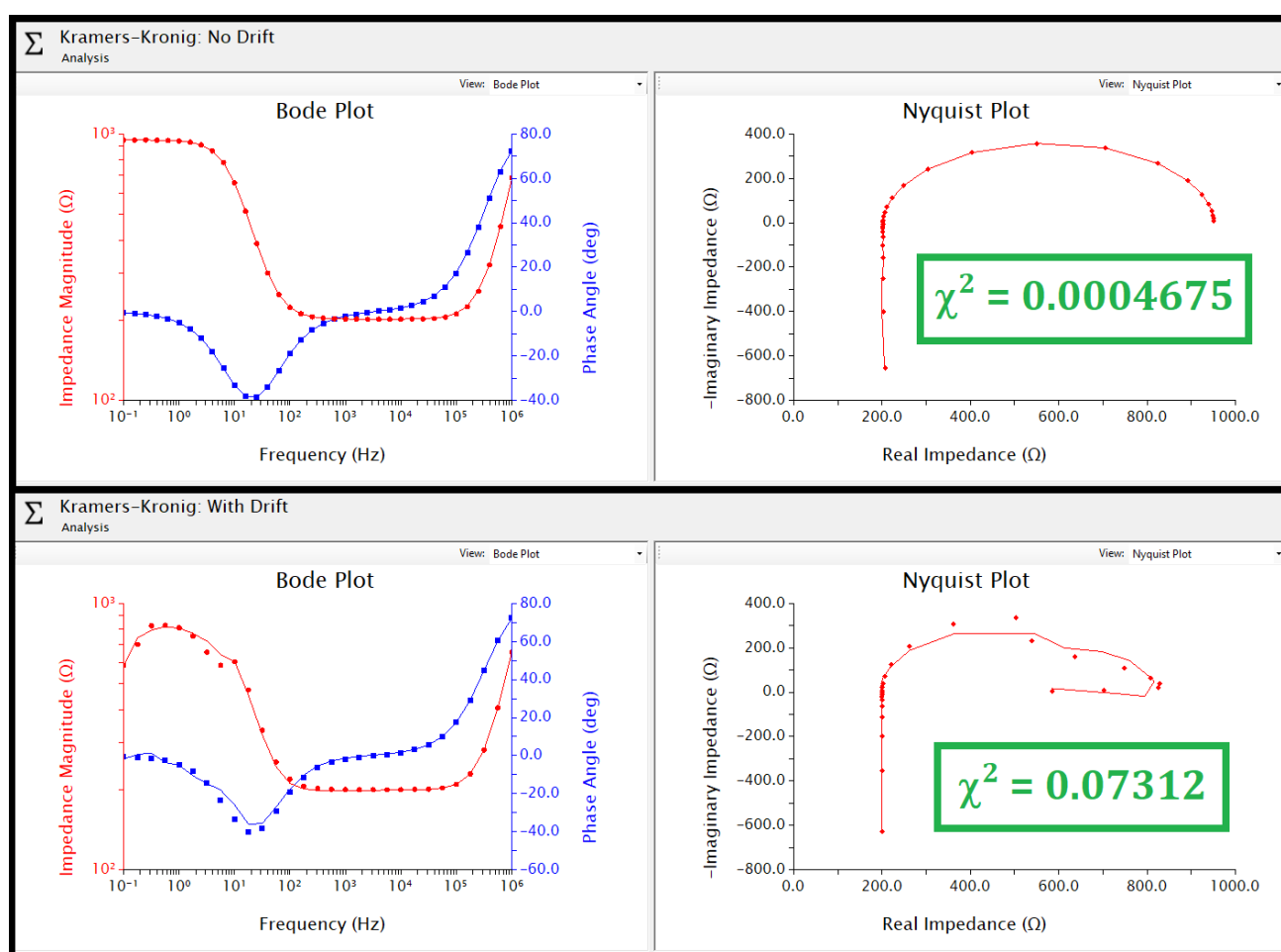

Figure 8-9. Effect of Drift on EIS Data and Kramers-Kronig Analysis

**NOTE:**

The quantity χ^2 is a measure of the “quality of fit” between experimental and fitted data. There are several different mathematical definitions of χ^2 , which are typically based on a sum of squared residuals. While there is no definitive value of χ^2 that is used as a baseline to separate “good” fits from “bad” fits, relative result quality may be determined by comparing χ^2 values across similar datasets with circuit fit and/or Kramers-Kronig analyses.

8.2 References

- (1) Orazem, M. E.; Tribollet, B. *Electrochemical Impedance Spectroscopy*; 2nd ed.; John Wiley & Sons, Inc.: Hoboken, NJ, 2017.
- (2) Lasia, A. *Electrochemical Impedance Spectroscopy and Its Applications*; Springer New York: New York, NY, 2014.
- (3) Jorcin, J.-B.; Pébère, N.; Tribollet, B. CPE Analysis by Local Electrochemical Impedance Spectroscopy. *Electrochim. Acta* **2006**, *51*, 1473–1479.
- (4) Hirschorn, B.; Orazem, M. E.; Tribollet, B.; Vivier, V.; Frateur, I.; Musiani, M. Determination of Effective Capacitance and Film Thickness from Constant-Phase-Element Parameters. *Electrochim. Acta* **2010**, *55*, 6218–6227.
- (5) Roy, S. K.; Orazem, M. E.; Tribollet, B. Interpretation of Low-Frequency Inductive Loops in PEM Fuel Cells. *J. Electrochem. Soc.* **2007**, *154*, B1378.
- (6) Orazem, M. E.; Durbha, M.; Deslouis, C.; Takenouti, H.; Tribollet, B. Influence of Surface Phenomena on the Impedance Response of a Rotating Disk Electrode. *Electrochim. Acta* **1999**, *44*, 4403–4412.
- (7) Orazem, M. E.; Agarwal, P.; Jansen, A. N.; Wojcik, P. T.; Garcia-Rubio, L. H. Development of Physico-Chemical Models for Electrochemical Impedance Spectroscopy. *Electrochim. Acta* **1993**, *38*, 1903–1911.
- (8) Remita, E.; Boughrara, D.; Tribollet, B.; Vivier, V.; Sutter, E.; Ropital, F.; Kittel, J. Diffusion Impedance in a Thin-Layer Cell: Experimental and Theoretical Study on a Large-Disk Electrode. **2008**.
- (9) Huang, V. M.; Wu, S.-L.; Orazem, M. E.; Pébère, N.; Tribollet, B.; Vivier, V. Local Electrochemical Impedance Spectroscopy: A Review and Some Recent Developments. *Electrochim. Acta* **2011**, *56*, 8048–8057.
- (10) Macdonald, D. D. Review of Mechanistic Analysis by Electrochemical Impedance Spectroscopy. *Electrochim. Acta* **1990**, *35*, 1509–1525.

- (11) Macdonald, D. D. Reflections on the History of Electrochemical Impedance Spectroscopy. *Electrochim. Acta* **2006**, *51*, 1376–1388.
- (12) Macdonald, D. D. Some Advantages and Pitfalls of Electrochemical Impedance Spectroscopy. *CORROSION* **1990**, *46*, 229–242.
- (13) Barsoukov, E.; Macdonald, J. R. *Impedance Spectroscopy: Theory, Experiment, and Applications*; 2nd ed.; Wiley.
- (14) Bertoluzzi, L.; Bisquert, J. Equivalent Circuit of Electrons and Holes in Thin Semiconductor Films for Photoelectrochemical Water Splitting Applications. *J. Phys. Chem. Lett.* **2012**, *3*, 2517–2522.
- (15) Bisquert, J. Influence of the Boundaries in the Impedance of Porous Film Electrodes. *Phys. Chem. Chem. Phys.* **2000**, *2*, 4185–4192.
- (16) Bisquert, J. Theory of the Impedance of Electron Diffusion and Recombination in a Thin Layer. **2001**.
- (17) Yuan, X.-Z.; Song, C.; Wang, H.; Zhang, J. *Electrochemical Impedance Spectroscopy in PEM Fuel Cells*; Springer London: London, 2010.
- (18) Agarwal, P.; Orazem, M. E.; Garcia-Rubio, L. H. Measurement Models for Electrochemical Impedance Spectroscopy. *J. Electrochem. Soc.* **1992**, *139*, 1917.
- (19) Agarwal, P.; Orazem, M. E.; Garcia-Rubio, L. H. Application of Measurement Models to Impedance Spectroscopy. *J. Electrochem. Soc.* **1995**, *142*, 4159.
- (20) Macdonald, D. D.; Urquidi-Macdonald, M. Application of Kramers-Kronig Transforms in the Analysis of Electrochemical Systems. *J. Electrochem. Soc.* **1985**, *132*, 2316.
- (21) Urquidi-Macdonald, M.; Real, S.; Macdonald, D. D. Application of Kramers-Kronig Transforms in the Analysis of Electrochemical Impedance Data. *J. Electrochem. Soc.* **1986**, *133*, 2018.
- (22) Boukamp, B.; Macdonald, J. R. Alternatives to Kronig-Kramers Transformation and Testing, and Estimation of Distributions. *Solid State Ionics* **1994**, *74*, 85–101.
- (23) Boukamp, B. A. A Linear Kronig-Kramers Transform Test for Immittance Data Validation. *J. Electrochem. Soc.* **1995**, *142*, 1885.

9. Glossary

Alternating Current (AC)	A type of electrical flow where the current direction rapidly changes, usually at regular intervals or in a sinusoidal pattern
Anodic Current	The flow of charge at an electrode as a result of an oxidation reaction occurring at the electrode surface. For a working electrode immersed in a test solution, an anodic current corresponds to flow of electrons out of the solution and into the electrode
Auxiliary Electrode	(see Counter Electrode)
Banana Cable	A banana cable is a single-wire (one conductor) signal cable often used to make connections between various electronic instruments. Each end of the cable has a banana plug. The plug consists of a cylindrical metal pin about 25 mm (1 in) long, with an outer diameter of about 4 mm (0.16 in), which can be inserted into a matching banana jack
Banana Jack	Female banana connector
Banana Plug	Male banana connector
BNC Connector	The BNC (Bayonet Neill-Concelman) connector is a very common type of RF connector used for terminating coaxial cables
Bode Plot	Standard plot representation of EIS data consisting of both impedance magnitude and phase angle (on separate vertical axes) vs. frequency. Impedance magnitude and frequency are typically plotted on a log scale, while phase angle is plotted on a linear scale
Cathodic Current	The flow of charge at an electrode as a result of a reduction reaction occurring at the electrode surface. For a working electrode immersed in a test solution, a cathodic current corresponds to flow of electrons out of the electrode and into the solution
Coaxial Cable	Coaxial cable, or coax, is an electrical cable with an inner conductor surrounded by a flexible, tubular insulating layer, surrounded by a tubular conducting shield. The term coaxial comes from the inner conductor and the outer shield sharing the same geometric axis. A coaxial cable is often used to carry signals from one instrument to another in situations where it is important to shield the signal from environmental noise sources
Counter Electrode	The counter electrode, also called the auxiliary electrode, is one of three electrodes found in a typical three-electrode experiment. The purpose of the counter electrode is to carry the current across the solution by completing the circuit back to the potentiostat
Cyclic Voltammetry (CV)	A DC electroanalytical method where the working electrode potential is repeatedly swept back and forth between two extremes while the working electrode current is measured

Direct Current (DC)	A type of electrical flow where the current travels in only one direction
Dummy Cell	A dummy cell is a network of known resistors, capacitors, and inductors that can be used to test or calibrate a potentiostat to ensure that it is working properly. The dummy cell is used in place of an actual electrochemical cell when troubleshooting a potentiostat because the dummy cell provides a known response, whereas the response from an actual cell is complicated by chemical phenomena
Electroactive	An adjective used to describe a molecule or ion capable of being oxidized or reduced at an electrode surface
Electrochemical Impedance Spectroscopy (EIS)	An AC electrochemical experiment where a series of sinusoidal potential or current waveforms are applied and the corresponding current or potential signals are measured and analyzed
Electrode	An electrode is an electrical conductor used to make contact with a nonmetallic part of a circuit
Electrostatic Discharge (ESD)	The rapid discharge of static electricity between objects with different charges. Sensitive electronics in the path of an ESD event may suffer damage
Faradaic Current	The portion of the current observed in an electroanalytical experiment that can be attributed to one or more redox processes occurring at an electrode surface
Half-Reaction	A balanced chemical equation showing how various molecules or ions are reduced (or oxidized) at an electrode surface
K1	A symbol referring to the primary working electrode. Two connections (drive and sense) are required between the working electrode and the potentiostat
K2	A symbol referring to the secondary working electrode. Two connections (drive and sense) are required between the working electrode and the potentiostat
Kramers-Kronig	Mathematical relations for the real and imaginary components of a complex system that define it as linear, causal, stable, and finite. Practically, it is used as an analysis tool on EIS data to determine whether or not the data is valid impedance
Linear Sweep Voltammetry (LSV)	A DC experiment in which the working electrode potential is swept from initial value to final value at a constant rate while the current is measured
Lissajous Plot	Plot of current vs. potential for sinusoidal EIS input and output signals. The shape and pattern of this plot can be indicative of the linearity and stability of the system under study
Mott-Schottky	A type of EIS experiment and analysis where an AC waveform of a single frequency, or a small range of frequencies, is repeatedly applied over a series of different potentials

Non-Faradaic Current	The portion of the current observed in an electroanalytical experiment that cannot be attributed to any redox processes occurring at an electrode surface
Nyquist Plot	Standard plot representation of EIS data consisting of imaginary impedance vs. real impedance
Overpotential	The overpotential is the difference between the formal potential of a half-reaction and the potential actually being applied to the working electrode
Oxidation	Removal of electrons from an ion or molecule
Redox	An adjective used to describe a molecule, ion, or process associated with an electrochemical (oxidation or reduction) reaction
Reduction	Addition of electrons to an ion or molecule
Reference Electrode	A reference electrode has a stable and well-known thermodynamic potential. The high stability of the electrode potential is usually achieved by employing a redox system with constant (buffered or saturated) concentrations of the ions or molecules involved in the redox half-reaction
Standard Electrode Potential	A thermodynamic quantity expressing the free energy of a redox half-reaction in terms of electric potential
Sweep Rate	Also called "scan rate", it is the rate at which the electrode potential is changed with time when performing a sweep voltammetry technique such as cyclic voltammetry or linear sweep voltammetry
Three-Electrode Cell	A common electrochemical cell arrangement consisting of a working electrode, a reference electrode, and a counter electrode
Two-Electrode Cell	A common electrochemical cell arrangement consisting of a working electrode and a counter electrode that also serves as the reference electrode
Voltammogram	A plot of current vs. potential from an electroanalytical experiment in which the potential is swept back and forth between two limits
Working Electrode	The electrode at which the redox process of interest occurs. While there may be many electrodes in an electrochemical cell, the focus of an experiment is typically only on a particular half-reaction occurring at the working electrode
Working Electrode Drive	The connection on a potentiostat or galvanostat through which charge flows to or from a working electrode. Drive lines have low impedance to allow significant charge flow (current) through the working electrode
Working Electrode Sense	The connection on a potentiostat or galvanostat that measures the potential of a working electrode. Sense lines have a high input impedance so that the potential can be measured without significant charge flow (current) through the sense line

10. Appendix I: Legacy Dummy Cell Information (before NOV 2020)

A WaveDriver 200 purchased before November 2020 was supplied with a different, legacy dummy cell. This section includes a description of that legacy dummy cell and also contains connection instructions corresponding to the potentiostat system testing in Section 4.

10.1 Legacy Dummy Cell Description

The dummy cell included with a WaveDriver 200 purchased prior to November 2020 was the EIS Calibration & Dummy Cell (Pine Research part number AFDUM5). Below is an image of this dummy cell, along with schematics of its four separate circuit networks.

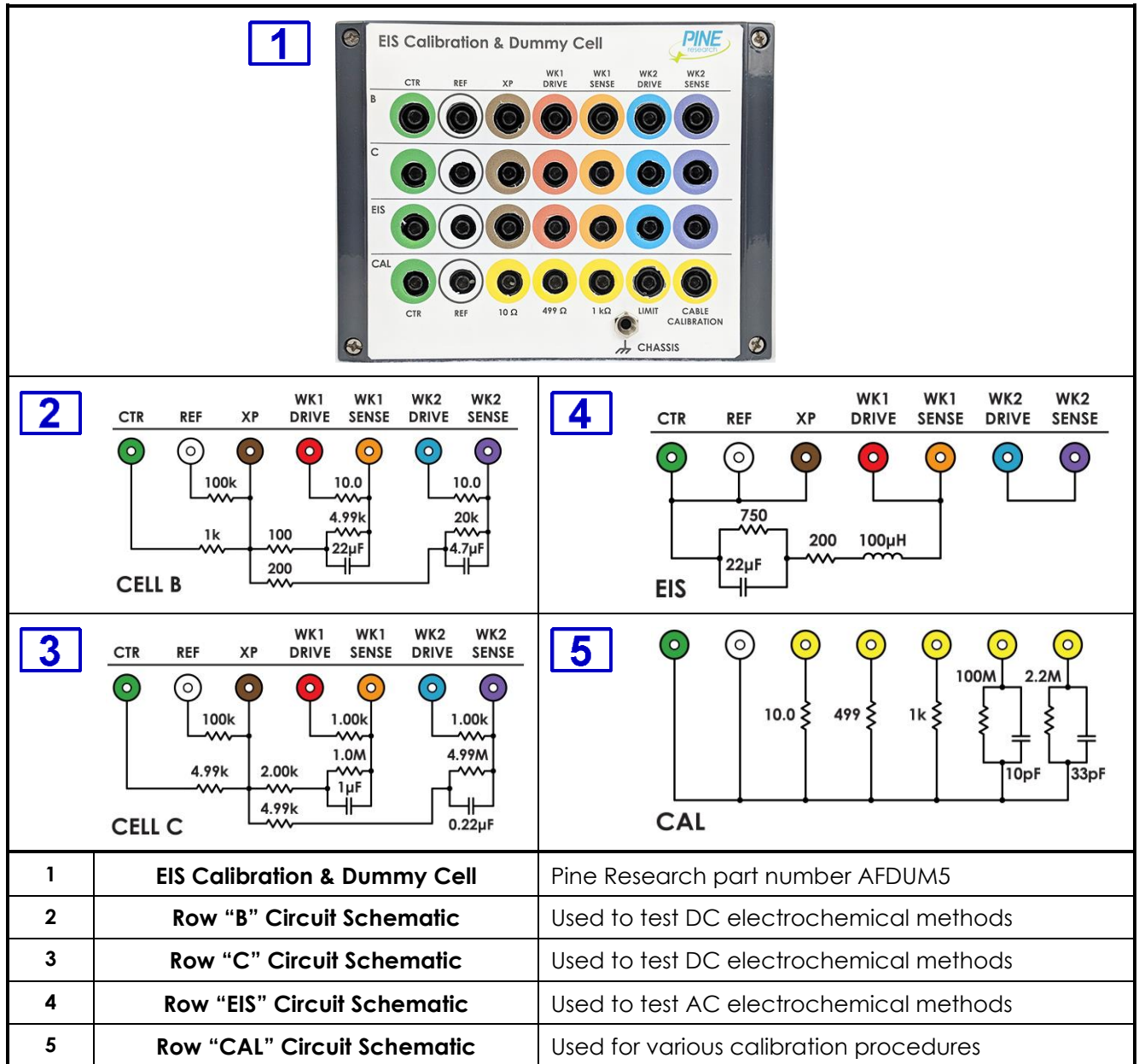

Figure 10-1. WaveDriver 200 Legacy EIS Calibration & Dummy Cell (with Schematic Diagrams)

The circuits for rows “B” and “C” of the dummy cell are used for testing the DC capabilities of the WaveDriver 200. These two rows have the same circuit topology; however, the values of the resistors and capacitors in the two circuits are different.

The circuit for the “EIS” row contains resistors, a capacitor, and an inductor. This circuit provides a predictable EIS response that can be used to verify the AC behavior of the instrument. The results are also useful for learning how to use the EIS circuit fitting feature in the AfterMath software (see Section 4.7).

The bottom “CAL” row on the dummy cell provides several different loads that can be used to verify the AC behavior of the instrument. The “cable calibration” load is a special circuit that is used to calibrate the cell cable capacitance (see Section 4.4).

10.2 Connecting to Row “C” on the EIS Calibration & Dummy Cell



NOTE:

This section includes instructions for connecting to the dummy cell corresponding to system testing in Sections 4.2 and 4.3.

Securely connect the cell cable to the front panel of the WaveDriver 200 (see Figure 10-2). Remove any alligator clips from the banana plugs and insert the plugs into the banana jacks with matching colors for each lead on Row “C” of the EIS Calibration & Dummy Cell. Be sure to connect the GRAY banana plug (instrument chassis) to the chassis terminal located on the EIS Calibration & Dummy Cell. Connecting the two chassis terminals together effectively shields the instrument circuitry and the components of the dummy cell within the same overall Faraday cage (see Section 6 to learn more about grounding).



Figure 10-2. WaveDriver 200 Cell Cable Connected to Dummy Cell Row “C”

10.3 Connecting to Row “CAL” on the EIS Calibration & Dummy Cell



NOTE:

This section includes instructions for connecting to the dummy cell corresponding to system testing in Section 4.4.

Securely connect the cell cable to the front panel of the WaveDriver 200 (see Figure 10-3). Position the EIS Calibration & Dummy Cell near the other end of the cell cable and locate the bottom row of banana jacks (labelled “CAL”). Note the position of the various colored banana jacks on this row.

Remove any alligator clips from the cell cable. Stack the banana plugs for the RED and ORANGE leads together (K1 drive and sense lines) and connect these stacked plugs to the yellow banana jack on the bottom row of the EIS Calibration & Dummy Cell labeled “CABLE CALIBRATION”. Also connect the banana plugs for the GREEN and WHITE leads (counter and reference electrode lines) on the cell cable to the corresponding individual GREEN and WHITE banana jacks. Finally, connect the GRAY banana plug to the dummy cell chassis.



Figure 10-3. WaveDriver 200 Connections for Cell Cable Calibration

10.4 Connecting to Row “EIS” on the EIS Calibration & Dummy Cell



NOTE:

This section includes instructions for connecting to the dummy cell corresponding to system testing in Section 4.7.

Connect the cell cable to the connector on the front panel of the WaveDriver 200. Remove all of the alligator clips from the cell cable and insert each banana plug into the proper banana jack on the EIS Calibration & Dummy Cell as shown (see Figure 10-4). Match the color of each lead to the banana jack with the corresponding color on Row “EIS” of the dummy cell.



Figure 10-4. WaveDriver 200 Connections for a Simple EIS Test

11. Appendix II. Legacy Grounding Information (before APR 2021)

A WaveDriver 200 purchased before April 2021 had a slightly different back panel grounding configuration. The DC Common was a black binding post and the instrument chassis terminal was a metal binding post. A metal shorting bar was also pre-installed when shipped from the factory that shorted the DC Common and instrument chassis (see Figure 11-1).

A summary of the four different common grounding configurations on WaveDriver 200s purchased prior to April 2021 is shown below (see Figure 11-1). These images correspond to the grounding strategies discussion in Section 6.6.

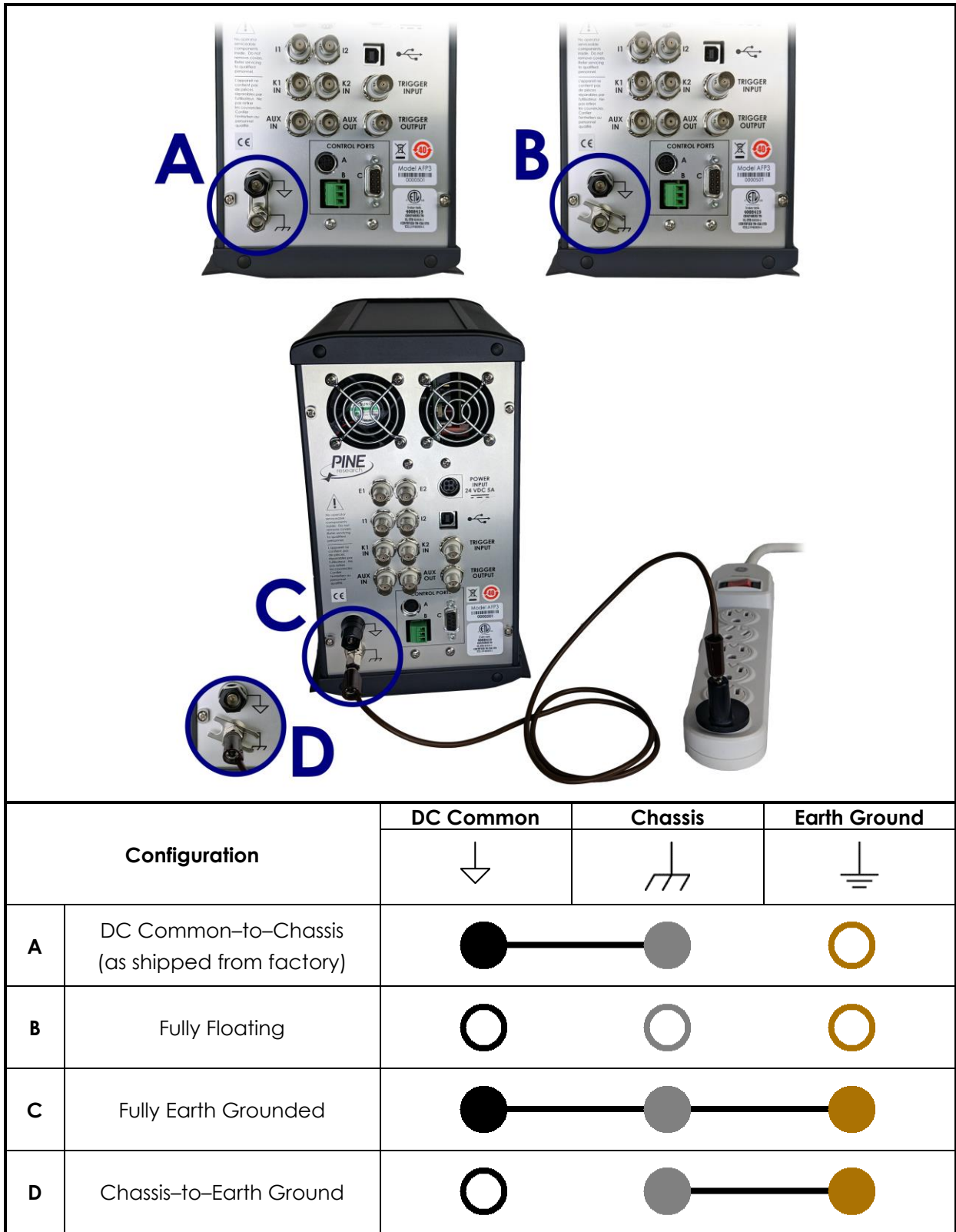

Figure 11-1. Four Common Instrument Grounding Configurations

12. Customer Support

After reviewing the content of this user guide, please contact Pine Research should you have any issues or questions with regard to the use of the instrument, accessories, or software.

Contact us anytime by the methods provided below:

12.1 Online

Our website has a contact form that allows users to submit technical support requests directly to Pine Research. Visit www.pineresearch.com/contact.

12.2 By E-mail

Send an email to pinewire@pineresearch.com. This is the general sales email and our team will ensure your email is routed to the most appropriate technical support staff available. Our goal is to respond to emails within 24 hours of receipt.

12.3 By Phone

Our offices are located in Durham, NC in the eastern US time zone. We are available by phone Monday through Friday from 9 AM EST to 5 PM EST. You can reach a live person by calling +1 (919) 782-8320.





EU Declaration of Conformity

In accordance with EN ISO 17050-1:2010

Object of the Declaration:

Products: WaveDriver 40 Bipotentiostat/Galvanostat
WaveDriver 100 Potentiostat/Galvanostat
WaveDriver 200 Bipotentiostat/Galvanostat

Models: AFP3, AFP4, AFP5

Serial numbers: 4318nnn and later (wwyynn: where ww is the week of manufacture; yy is the year of manufacture; nnn is a number indicating model and sequence of build)

Manufacturer: Pine Electronics, Inc.
Address: 101 Industrial Drive, Grove City, PA, 16127, USA

This declaration is issued under the sole responsibility of the manufacturer.

The object of the declaration described above is in conformity with the relevant Union harmonization legislation:

Directive	Title
2014/35/EU	The Low Voltage Directive
2014/30/EU	The Electromagnetic Compatibility Directive
2011/65/EU	The Restriction of Hazardous Substances Directive

Conformity is shown by compliance with the applicable requirements of the following documents:

Reference and Date	Title
EN 61326-1:2013	EMC Requirements for electrical equipment for measurement, control and laboratory use
IEC 61010-1:2010, AMD1:2016	Safety Requirements for electrical equipment for measurement, control and laboratory use

Signed for and on behalf of: Pine Electronics, Inc./Pine Research Instrumentation, Inc.
Place of Issue: Grove City, PA, USA
Date of Issue: 03/04/2019
Name: Edward T. Berti
Position: Principal Engineer
Signature:

The technical documentation for the machinery is available from the above address.

The CE Mark was applied per the following reports:

Keystone Compliance: 1807-092EB

Intertek: 103640745COL-001 and 103640745COL-002